

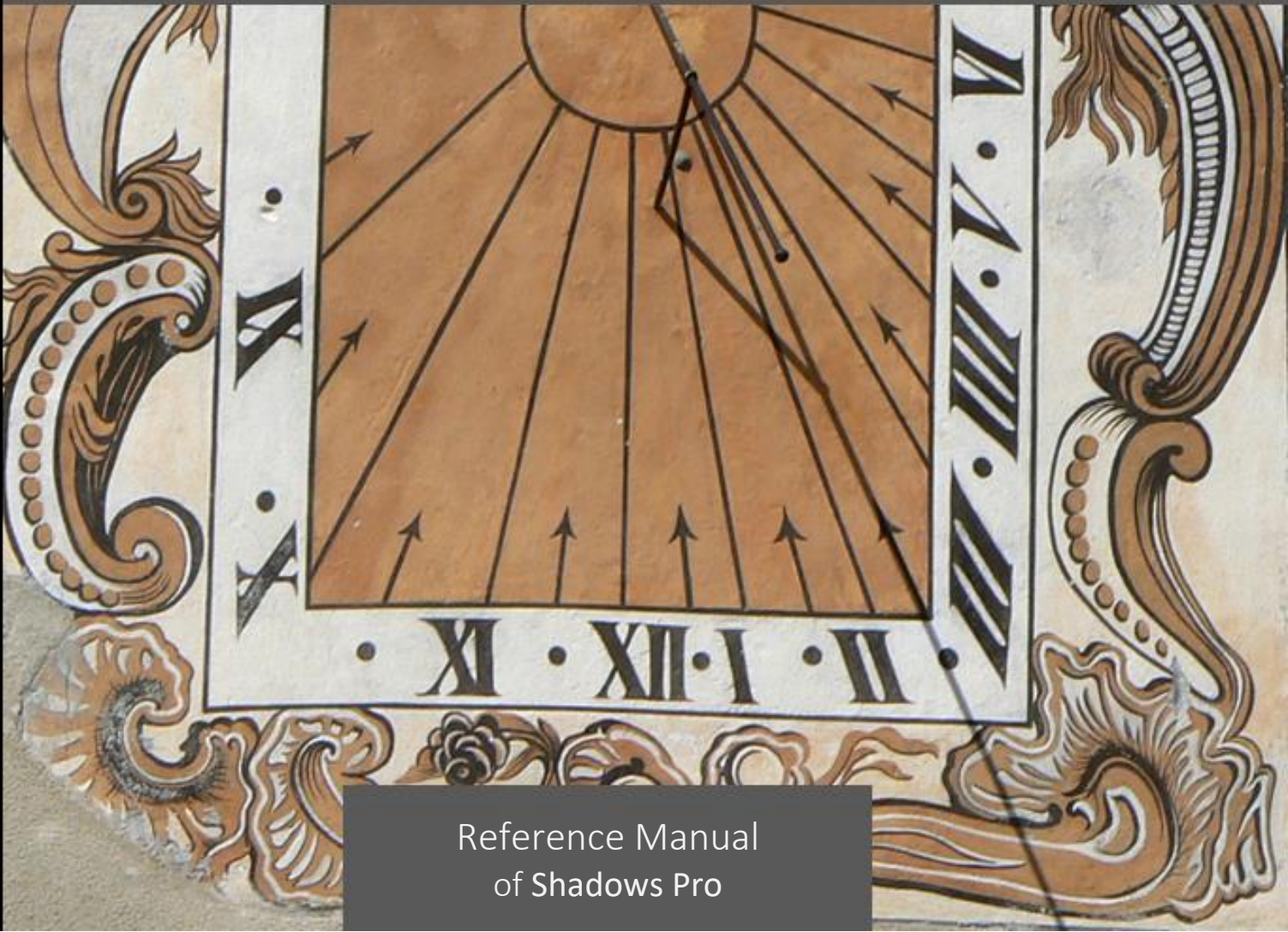

# Sundials & Astrolabes

François Blateyron



Reference Manual  
of Shadows Pro

This manual is the reference for [Shadows Pro](#).

© Copyright 2014-2019 by François Blateyron.

Reproduction and/or copy of part of this manual strictly forbidden without written authorization of the author.

Version last updated on August 17, 2019

Dear Shadows® user,

The Shadows software is the result of many years of work, thousands of hours of development in order to make easy to use the science of sundials and astrolabes.

I started to develop Shadows in 1996 and I published it for free on the Internet in 1997 while a few homes only were connected. During the following years, Web surfers have submitted suggestions, have contributed to test the new features and have offered to translate the user interface and the user manual.

Twenty year after, Shadows is the most popular software for the design of sundials. Tens of thousands of users around the globe are using Shadows, as simple enthusiast, serious amateur or professional sundial maker.

I spent long hours to write this manual, which goes far beyond the simple explanation of the software features, and is a genuine reference on sundials, astrolabes and other astronomical tools. During the development of the software as well as when writing the manual, I have been vigilant to turn complex concepts and equations into easy-to-use features, in order to allow non-specialists and general public to enjoy.

If you only discover Shadows, you will see that the freeware version is really complete and of great quality. However, I encourage you to acquire a Shadows Pro license to enjoy the power of the full version and to support its development. I regularly receive messages of users from around the world, sometimes with photos of the sundials they made using Shadows – they can be seen in the gallery of sundials made by users on the Web site [www.shadowspro.com](http://www.shadowspro.com). Do not hesitate to send your realizations.

Thanks for supporting this work and enjoy reading this manual.

**François Blateyron**

*This page is left intentionally blank*

# PART 1 – INTRODUCTION TO SHADOWS SOFTWARE

## Introduction

**Shadows** is a software package for designing, calculating and drawing sundials and astrolabes. It is designed and developed in France by François Blateyron. Shadows celebrated in 2017 its twentieth anniversary of presence on the Internet!

Users are provided with a complete toolbox with which to build, orient and understand all kinds of sundials. It draws the different parts of an astrolabe and allows the user to move the mobile parts on screen. Shadows also offers complete solar and lunar ephemeris and several graphs and tools related to the Sun. It is a great educational tool for teachers, animators and children.

Shadows in its standard level, is a freeware program. You can use it freely for your personal use and even distribute it to your friends, provided you keep all original files together (including the installation program and documentation). This standard version contains many useful functions and allows the construction of various types of sundials.

**Shadows Expert** is an advanced level provided for skilled users wishing to explore more technical features and additional sundial types. **Shadows Pro** is made for the most experienced, sophisticated and demanding users and professional sundial makers. These two latter versions, **Shadows Expert** and **Shadows Pro**, require the purchase of a license (see [www.shadowspro.com/license](http://www.shadowspro.com/license)).

Please report bugs or problems, and send photos of sundials you may have constructed, by sending an E-mail to:

[info@shadowspro.com](mailto:info@shadowspro.com) or [fblateyron@shadowspro.com](mailto:fblateyron@shadowspro.com)

Check out the web site for new versions:

[www.shadowspro.com](http://www.shadowspro.com)

Shadows allows for automatic detection of new versions as they become available on the web site – if the computer is connected to the Internet. If a new version is available, a message will inform you to download it or to consult the page that describes the new version. This function can also be launched manually from **Help**

>  **Check if a new version is available ...**

## Installing Shadows on a PC

Shadows is developed for Windows® and in particular, the latest versions: Windows 10, Windows 8.1, Windows 8, Windows 7, and Windows Vista. **Shadows** is a 64-bit application that requires a 64-bit version of Windows. Under some circumstances, Shadows can also run under MacOS using **Wine**, **Parallel Desktop** or **VMWare**. Note that technical support will be provided only for Windows platforms.

### Instructions to install Shadows

1. **Download the latest version** of Shadows on [www.shadowspro.com](http://www.shadowspro.com)  
(the installation file **shadows.exe** is approximately 20 MB and can be downloaded in tens of seconds)  
Note: if you install Shadows from a USB key, skip this part.
2. **Start installation**
  - a. During the installation, choose the language and click on **Next**

- b. Read the End User License Agreement, if acceptable, check the box: [I understand...](#) then click on [Next](#)
    - c. Click again on [Next](#), unless you need to change the installation folder.
    - d. Select how you want the icons to be created and click on [Next](#),
    - e. Wait until the installation is finished.
    - f. Finally click on [Finish](#).
  3. The program is now installed.
    - a. Under Windows 7 or earlier versions: you can access to Shadows from the Start menu > All programs > Shadows
    - b. Under Windows 8 and later: access Shadows by typing its name in the Search area, or by installing it as a “tile” in the Windows screen.

## Installation of the Shadows license file

When a [Shadows Expert](#) or [Shadows Pro](#) license is ordered, it is delivered by E-mail in the form of an encrypted text file and an activation code. The license is included on the USB key when the box version is ordered.

1. Copy the license file into the folder [Documents\Shadows Data](#)
2. Start Shadows. A dialog should ask you to associate the license with your PC. See below the procedure.

**Important!** Please keep a copy of your license file in a safe place in case you need to reinstall your hard drive or change to a new PC.

## Associate the license with the PC

The license has to be associated with the PC. The association procedure is automated if you have an Internet connection.

When the license is installed but not yet associated, a dialog box is displayed at launch. Certify that you own the license and click on the button [Associate the license to the PC](#).

Once the license is associated, you do not need to be connected to the Internet.

If you get an communication error at this stage, see [Manually associate the license](#) below.

## Manually associate the license

If you do not have an Internet connection, or if there was a communication error during association, you need to send to [fblateyron@shadowspro.com](mailto:fblateyron@shadowspro.com) the text file located in [My Documents > Shadows Data > Association](#). Your manually associated license will be sent back to you by E-mail and you will need to copy it into [Documents > Shadows Data](#).

## Credits

Shadows has been fully designed and developed by [François Blateyron](#) (the author). The user manual, illustrations and photographs are also by the author. The [Société Astronomique de France](#) (French Amateur Astronomy Society) awarded the author with the [Julien Saget Price](#), for the Shadows software.

The author wishes to thank the people who helped him during the development by sending suggestions, testing the program or translating parts of the documentation or the user interface.

Translations of the user interface have been kindly provided by:

<a href="#">English</a>	collective contribution
<a href="#">German</a>	Claudio Abächerli, Carmen & Axel Wittich, Sonja Lejeune, Marco Tomljanovich, Karl-Peter Emmelmann, Christian Haack, Hermann Dellwing, Rita Gautschy, Siegfried Netzband, Ignaz Lorenz
<a href="#">Spanish</a>	Carlos María Sánchez Rodríguez, Gilberto De Hoyos C, Jesús San José Hernández, Mario D. Crespo, Isabelle Blateyron, Rafael Rodríguez Martín, Vicente Javier Fernández Gallego, Eduardo Bolufer Catalá
<a href="#">Italian</a>	Claudio Abächerli, Marco Tomljanovich, Federico Bettinzoli, Luigi Massimo Ghia
<a href="#">Portuguese</a>	Hugo D. Valentim
<a href="#">Brazilian Portuguese</a>	Hugo D. Valentim, Rogério Luís Brochado Abreu, Juarez Silveira Sant'Anna, Willyan Becker
<a href="#">Dutch</a>	Fer J. De Vries, Thibaud Taudin-Chabot
<a href="#">Hungarian</a>	Tulok László
<a href="#">Russian</a>	Serge Zukanov, Alexei Krutiakov
<a href="#">Slovenian</a>	Stane Accetto
<a href="#">Polish</a>	Maciej Michalski, Mirosław Danch
<a href="#">Greek</a>	Vangelis Skarmoutsos
<a href="#">Czech</a>	Jaromír Ciesla
<a href="#">Arabic</a>	Ahmed Ammar, Kamoun Sofien
<a href="#">Catalan</a>	Gabriel Guix
<a href="#">Romanian</a>	SRPAC / Radu Anghel & Dan-George Uza

Help files and the user manual have been translated by:

<a href="#">English</a>	collective contribution
<a href="#">German</a>	Karl-Peter Emmelmann, Siegfried Netzband, Nicolas Feierstein, Rita Gautschy, Hermann Dellwing
<a href="#">Spanish</a>	Rafael Rodríguez Martín, Carlos María Sánchez Rodríguez, Vicente Javier Fernández Gallego
<a href="#">Italian</a>	Marco Tomljanovich, Luigi Massimo Ghia
<a href="#">Brazilian Portuguese</a>	Juarez Silveira Sant'Anna
<a href="#">Polish</a>	Maciej Michalski
<a href="#">Czech</a>	Jaromír Ciesla

Many thanks also to the many users who helped testing Shadows, who suggested ideas of new features or contributed to promote Shadows around the world.

Special thanks to **Kurt Berndt** for proof reading, correcting and improving this manual in English.

## Features of the three license levels

### Shadows (freeware)

Shadows in its basic level is free.

It comes with a powerful set of functions and a full documentation. Features included in Shadows include:

- Plane sundials with polar style (horizontal, vertical declining, equatorial, polar, meridian),
- Sundial drawn to scale 1, of any size and any orientation or reclination,
- Compatible with any location on Earth, in northern or southern hemisphere (5,000+ locations installed),
- Style drawn to scale 1,
- Tables of coordinates of hour line points and declination arcs,
- Reporting of solar or mean time, with or without longitude correction,
- Text frames that can be moved and resized on the sundial, with preinstalled list of mottoes in Latin, English, German or other languages,
- Export of coordinates to Excel
- Copy-paste of drawings in bitmap format
- Equation of time drawn in various forms,
- Drawing of a protractor and azimuth circle,
- User manual of more than 120 pages, fully illustrated
- User interface translated in 17 languages,

### Shadows Expert

**Shadows Expert** is a level dedicated to users who want to access to more advanced functions in the program. Shadows Expert adds the following features to Shadows:

- Analemmatic sundials,
- Cylindrical sundials (shepherd's dial, polar, armillary ring, vertical cylinder),
- Spider sundial,
- Solar ephemeris tables,
- Drawing of Italic and Babylonian hours,
- Insertion of image frames and cliparts on the sundial,
- Export of images in EMF format (vector format),
- Drawing of the construction layout of a sundial,
- Simulation of the roof's shadow on the sundial,
- Change of orientation and reclination of a sundial,
- Tool for the determination of a wall's declination,
- Direction rose,
- Mariner's astrolabe,
- Planisphere (mobile sky chart),

### Shadows Pro

**Shadows Pro** is the most advanced level and is made for professional sundial makers and power users. Shadows Pro adds the following features to Shadows Expert:

- Planispheric and universal astrolabes,
- Vertical declining analemmatic sundial,
- Bifilar sundials,
- Drawing of azimuth and altitude lines on the sundial,
- Sidereal and astronomical hour lines,
- Colored background outside solstice arcs
- Colored background between declination arcs
- Lunar ephemeris

- Solar graph (azimuth-altitude) with horizon mask,
- Export of drawing layout in DXF (AutoCAD),
- Tool for the calculation of sundial parameters from a photo,
- Efficiency graph of a solar panel,

## Order a Shadows Expert or Shadows Pro license

**Shadows** has been the only freeware program to offer so many simple to use and powerful features for designing sundials. Available since 1997, Shadows continues to evolve and improve with new features but remains simple and easy to learn and use.

Shadows is the result of several years of work and countless hours of programming in order to provide a simple way to access to the underlying science of sundials and astrolabes. By ordering a **Shadows Expert** or **Shadows Pro** license, you not only unlock the full potential of the program, but also support the development efforts by the author and contribute to improving the program.

Shadows is the freeware level that everybody can download and use.

Advanced levels, Shadows Expert and Shadows Pro require the purchase of a license. Prices are given on the page **Buy Shadows Pro** on [www.shadowspro.com](http://www.shadowspro.com)

Do not hesitate, upgrade to Shadows Pro and enjoy its powerful features!

*This page is left intentionally blank*

## PART 2 – SUNDIALS

### Introduction to sundials

A sundial is a device from which time can be read using the position of the Sun, or more precisely using its **hour angle**, or sometimes its **altitude**. Known since the most ancient times in its most simple form, it spread from the renaissance to the 19<sup>th</sup> century and then slowly became obsolete, due to the growing success of horology. People started to be interested again by sundials after the 1980s and the subject is very popular today.

Studying sundials will allow you to discover various disciplines: history, techniques of art (fresco, engraving, etc.), philosophy of mottoes, celestial mechanics, and many more.

It is possible to design a sundial on just about any support (plane, cylindrical, spherical...), of any orientation and for any location. This manual describes several types of sundials but other types exist, sometimes more exotic than useful. The layout of a sundial (lines, arcs, texts) can be very diverse and can provide all kinds of information: solar time, civil time, season, date, Sun's declination, hour of sunrise or sunset, hour of another city, etc.

If you intend to design your own customized sundial, you will find everything you need in this manual. You can start by downloading the freeware program Shadows that will do all the calculations for you and print all the drawings you need.

### Designing a sundial with Shadows

#### Preliminary information to collect

Before starting the design of a sundial, you need to collect information that will be required during the creation process.

1. Location of installation
2. Orientation and/or reclination of the support
3. Type of sundial

Once the sundial is designed, you may configure the following options:

- Dimension of the sundial plate (width/height) and its shape (rectangle, disk, ...),
- Indications given by the sundial (solar hours, Babylonian hours, ...),
- Furniture, motto, labels on the drawing.

#### Location of installation

Contrary to commercial sundial sold in garden shops and designed for an average latitude, your sundial can be customized specifically for your location. The location is defined by its **latitude**, its **longitude** and its **time zone**.

Shadows includes a database of 4,500 locations already configured. You may also want to add your favorite locations. For a sundial marking solar time, only the latitude matters. For a sundial of civil time which includes the longitude correction, longitude and time zone will be required. Other location files can be downloaded from the page [www.shadowspro.com/en/downloadlocations.html](http://www.shadowspro.com/en/downloadlocations.html), with a total of more than 300,000 locations, compatible with the Shadows database.

A precision of 1 arc-minute is enough for the longitude as it corresponds to 1 km to 1.5 km of distance in the East-West direction. With a precision of 1 arc-second, you can reach 20 meters.

## Orientation of the sundial plate

Contrary to what most people think, sundials do not necessarily need to face south. It is possible to have them declining towards east or west, or even north. It just requires illumination by sun light for at least part of the day, part of the year.

The **declination angle** is the horizontal angle between the direction perpendicular to the wall and the direction of the local meridian. If the wall is facing exactly south, its declination is zero. If it faces east, the declination will be 90° east.

The **inclination angle** is the vertical angle between the horizontal plane and the sundial plate. A vertical sundial is inclined by 90° while a polar sundial is inclined by the latitude of the location.

## Dimension of the sundial

Do you want to create a monumental sundial for your town square or just a pocket sundial? It is time to think about consequences of the size. With a small sundial, you can print its drawing on one or several sheets of paper and transfer the drawing onto the final material. With a larger sundial, you will need to draw lines using their coordinates and angle. The weight of the sundial is also important, especially if you plan to install it high on the wall of your house.

## Type of sundial

Do you want to make a sundial with a polar style? Or with just a perpendicular style (gnomon)? Or an analemmatic sundial, a shepherd's sundial or an armillary sphere? Before starting, check the type of sundial that would best fit your needs.

## Indications given by the sundial

The sundials that we see during holidays are usually giving local solar time. But sundial can provide other types of information. Read the section called **Indications given by the sundial** to know what information can be displayed on your sundial. It will also impact its readability, its design and its aesthetic.

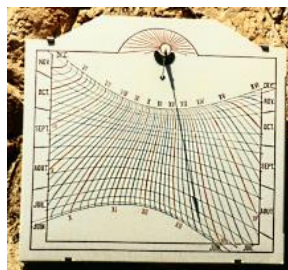
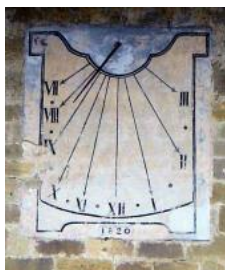

## Decoration

Many considerations go to the decoration of a sundial including its shape, the color of the plate, the shape of the style, the color of hour lines and declination lines, the border, the font used for text labels and the motto, the motto text itself and any drawing you may add on the sundial (animals, landscape, church...), to name a few.



## Quick creation of a sundial from the home screen

When you launch Shadows, a home screen with icons is displayed. Icons allow users to select the main features.

If you use the freeware level Shadows, some features are locked and indicated by yellow or red markers in the upper right corner, depending on whether they are enabled in Shadows Expert or Shadows Pro, respectively.

A Shadows Pro license allows unrestricted access to all features in the program.



You can display the home screen at any time by clicking on the icon  on the top left tool bar.

## Create a new sundial from the File menu

A sundial can also be created with the help of a 3-stage wizard by selecting **File** >  **Create a Sundial ...**

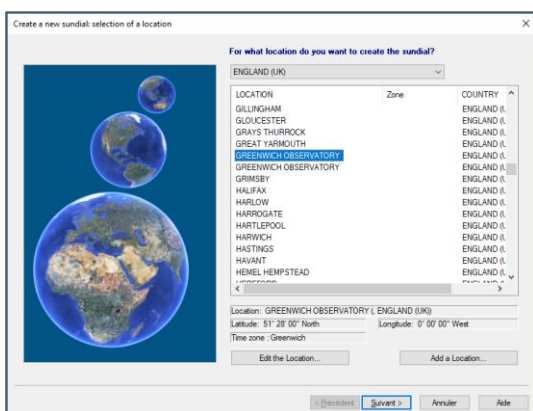

In the first screen, choose the location where you plan to install the sundial. Select the country from the top roll over list and select the city from the main list.

If your location is not in the list you can add it.

Usually it is sufficient to choose a city near your exact location, a difference of a few kilometers is not usually significant.

Click on **Next** >

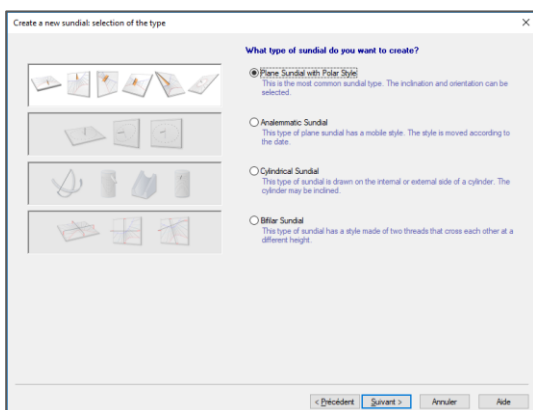

In the second screen, choose the category of sundial from:

- Sundial with polar style (classical)
- Analemmatic sundial
- Cylindrical sundial
- Bifilar sundial

Click on **Next** >

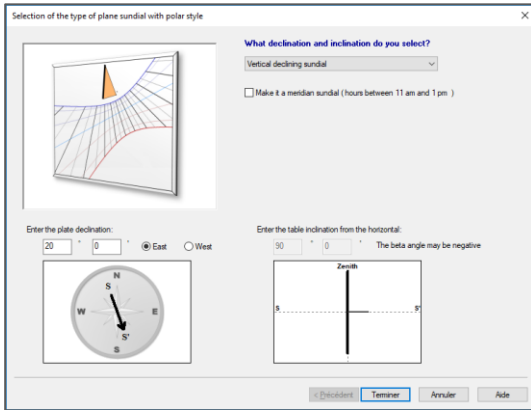

For a **sundial with polar style**, select the type from the roll over list.

In case of a declining sundial (or reclining), you need to enter angles in the edit field above drawings.

Each sundial may be configured as a meridian dial that is read only between 11 am and 1 pm if you click on the check box **Make it a meridian sundial**

Click on **Finish**

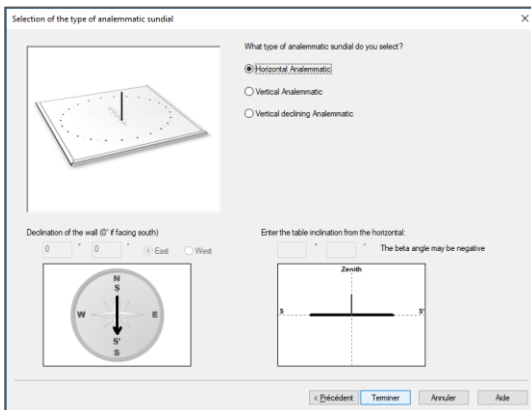

For an **analemmatic sundial**, select its type using the radio buttons.

In case of a vertical declining sundial, select its declination angle.

Click on **Finish**

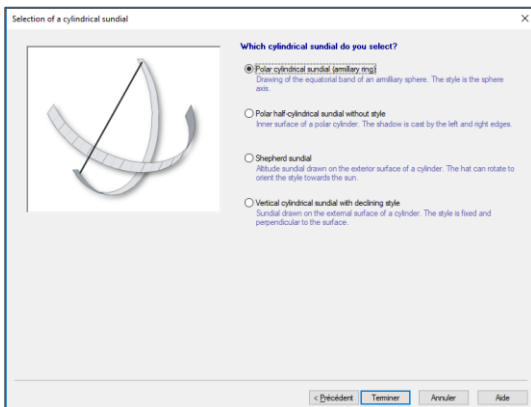

For a **cylindrical sundial**, select its type using the radio buttons.

Click on **Finish**

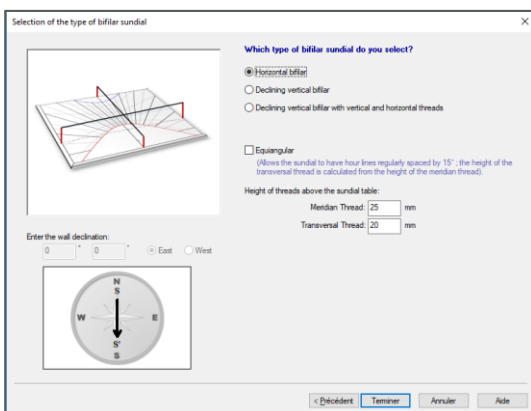

For a **bifilar sundial**, select its type using the radio buttons and set the height of both threads.

Click on **Finish**

## Choose a place for your sundial

One can install a sundial anywhere, as long as it receives some light from the sun during a part of the day. The majority of people think that only a wall oriented south (or north in the southern hemisphere) can receive a sundial, but you should not restrict your choice to that. On the contrary, the most original dials (regardless of their decoration) are almost always oriented between the cardinal points, and sometimes they are not vertical.

You should consider the following points before selecting a site:

- duration of daily illumination during the year,
- visibility from the street or the garden,
- exposure to bad weather (wind and rain),
- accessibility for the sundial installation,
- risk that plants and bushes may obscure the sundial,
- risk of deliberate defacement or robbery,
- risk of injury to people caused by the style (especially for a metal style on a horizontal or equatorial dial).

Below, are some possible places for the installation of a sundial:

### In the garden

- A horizontal or equatorial sundial can be placed on a small column at the junction of two paths. The column should not exceed 1.2 meters in height.
- A meridian dial can decorate a pillar or a tree facing south (north in southern hemisphere) in a place lit around midday all the year.
- An armillary sphere, a kind of equatorial dial drawn on arches, can replace a sculpture in the middle of the garden.
- On one (or both) of the pillars of the entry gate. The dial offers the time to the passers-by and reminds them that the landowner is a sundial lover.
- A staircase, with its stone or concrete handrail, can receive a declining and inclining sundial, a supreme luxury as it is rare and difficult to design (except with the help of Shadows!).

### On the front of a house

- A wall facing the south (north) will be adequate for a vertical direct south (north) dial. If the wall is slightly declining, you can still orient the face of the dial directly south (north) using shimps.
- A wall facing east (exactly or declining between 80° and 100°) or facing west, is an excellent place for a nice direct east, a direct west or a vertical declining sundial. These dials are lit only during the morning or the evening. Their drawing is somewhat Spartan, so they are often richly decorated and have a motto adapted to the rising or setting of the sun.
- A wall declining between from 20° to 70° towards east or west offers more possibilities. The hour lines in this case are already a nice decoration on their own.
- A wall facing the pole? A direct north (south) sundial, lit for only a few moments in the day (and almost never during the winter) would be an interesting object with an eccentric decoration and an incisive motto.
- Above the entrance door of the house, so that visitors can see the dial and its motto which affirms the hospitality of the occupants of the house.

### Inside the house!

- Facing a picture window, under a bow window, in a corridor facing the east and lit at the sunrise anywhere inside the house, where the sun enters and shines directly the dial in the room. In this case, the sundial could be made from a more delicate and precious material than an external dial.
- On the ceiling, with a mirror to send the sunlight upwards. In this case, the lines must be reversed, but the originality is guaranteed!

## On the roof of the house!

- Why not use the slope of the roof to make a large sundial visible for more than a hundred meters from the house? The style can be installed for the occasion, but you can also use the chimney or an antenna. A polar sundial can be suitable for houses oriented North-South.

## Elsewhere...

- On the wall of the local school. It is a good opportunity to set up an educational project with the pupils, teachers and parents. Concepts of celestial mechanics, astronomy, calendars and time become relevant topics. Workshops covering topics from the design to the installation can be planned. And why not have an official opening with an inaugural speech by the mayor or the headmaster?
- On a building in your village or town. Do not hesitate to propose a project to your mayor, he will surely be interested.
- On your neighbors' house.

If you discuss sundials with people around you, they will probably ask questions and may eventually ask you to prepare one for them.

## Determine the longitude and latitude of a place

Establishing the geographical location of the sundial is fundamental for the precision of the dial. The simplest solution is to use a GPS device or a smartphone. You'll get the position with precision to a fraction of an arc second which is more than sufficient.

You can also do it with a map of the location having a very precise scale like 1:100000 or even better 1:25000. You will have to find your geographical **longitude** and **latitude**. Both can be measured using the method of interpolation.

Note: in order to achieve a reliable interpolation, the two references shouldn't be too far apart to compare the charted area accurately. Maps are made using a Lambert projection that is approximately square over short distances.

## Find the longitude

First find on the map a vertical line left and right of the actual place. Find the readings of those lines, being G1 and G2. Using a graduated ruler measure the distance in cm (or mm) L1 between those two lines. Next measure the distance L2 between the vertical line G1 left of the place if east of the Greenwich meridian or right of the place if west of Greenwich meridian. The longitude will be:

$$LONGITUDE = G1 + (G2 - G1) * L2 / L1$$

with G1 and G2 as longitudes left and right of the location (or in case of a western longitude right and left of the location).

For example: for the village Villers Buzon, France (Doubs):

(using a 1:25000 map)

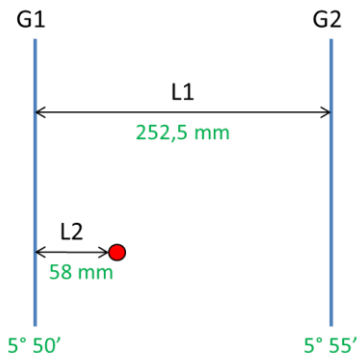

$$\begin{aligned}
 G1 &= 5^\circ 50' \\
 G2 &= 5^\circ 55' \\
 L1 &= 252,5 \text{ mm} \\
 L2 &= 58,0 \text{ mm} \\
 \text{Longitude} &= 5^\circ 50' + (5') * 58,0 / 252,5 \\
 &= 5^\circ 51' 09'' \text{ Est}
 \end{aligned}$$

A precision of 1 minute is sufficient. Make sure you take the readings in degrees and not in grads which are sometimes also used on maps.

## Find the latitude

Proceed as described above except that you now have to use the horizontal lines to be marked as G1 and G2.

For Villers Buzon:

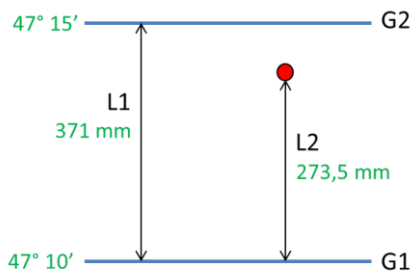

$$\begin{aligned}
 G1 &= 47^\circ 10' \\
 G2 &= 47^\circ 15' \\
 L1 &= 371,0 \text{ mm} \\
 L2 &= 273,5 \text{ mm} \\
 \text{Latitude} &= 47^\circ 10' + (5') * 273,5 / 371,0 \\
 &= 47^\circ 13' 41''
 \end{aligned}$$

## Enter the location in the database

Once you have found the coordinates enter the location in the database in order to conveniently use the readings again for another sundial at this location.

Tools menu >  Edit the location database...

Or when creating a sundial, click on [Add a location...](#)

You can enter the geographical coordinates with an accuracy of 1 arc-second.

The time zone is very important. In Western Europe, the time zone is UT+1h (except for UK and Portugal that are at UT).

If you do not know the coordinates, you may find them from [Google Maps](#) or [Google Earth](#) and copy-paste them directly in Shadows.

To know how to import coordinates, read the section [Add new locations to the database](#) at the end of this manual.

## Find the direction of the local meridian

The local meridian indicates the north-south direction and defines the meridian plane which contains the style of almost all types of sundials. It is therefore usually useful to know precisely where the direction of the meridian is in order to align a sundial.

Several methods for defining the local meridian are given below. It is interesting and educational to try them all and compare their results.

### Using a compass

A compass indicates the direction of the magnetic pole. But the meridian direction relies on the geographic pole that is not located at the same point as the magnetic pole. On some maps, one can find the magnetic declination of the pole and use it to correct the compass direction. The difference between the magnetic and geographic poles can reach 20° to 30° in some regions, as in North America! Nowadays, the magnetic pole is located 82° North, 113° West, in the north part of Canada (See the following site for more information). Some locations have local magnetic disturbances (due to mountains for example) and it is sometime necessary to check the value of the local magnetic declination on a map. The magnetic declination evolves rapidly with time.

## US/UK World Magnetic Model - Epoch 2015.0 Main Field Declination (D)

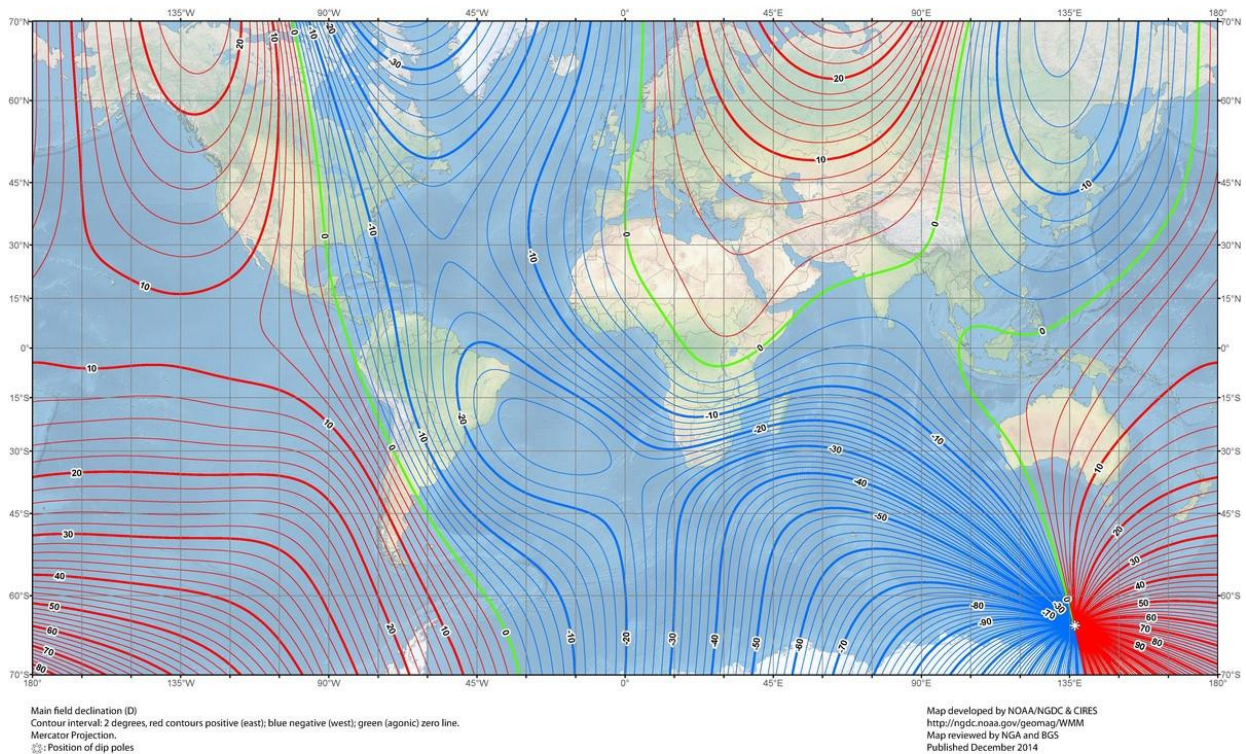

Source: <http://www.magnetic-declination.com/what-is-magnetic-declination.php>

The map above gives the magnetic declination between the directions of the magnetic north and the geographical north, in blue for a declination towards West and red towards East. The declination is quite high in eastern Europe, Africa or China.

The measurement should be made using a precise compass, graduated in half-degrees. In order not to disturb the reading, you must be away from any metallic object such as cars, drainpipes, walls with metallic structure, etc. Then the compass reading must be corrected by the magnetic declination.

### Using the Sun's passage to the meridian

You will need a vertical plumb line above a horizontal ground (or table). Using Shadows ephemeris, calculate when the Sun will pass the meridian for your location on a given date. At that precise instant, the shadow cast by the Sun is aligned exactly with the meridian. Mark the position of the shadow on the ground. Place another mark right below the plumb line. The meridian is the line joining these two marks. The drawback of this method is that it is only valid at one instant. If a cloud blocks the sun at that instant, you need to wait another day. A better value is often obtained by averaging several measurements made at different days.

### Using bisectors

You need a vertical plumb line above a horizontal piece of wood or a table. Draw a series of concentric circles from a center point above which you install the plumb line. You can attach a small ball on the line in order to have a clear shadow of the line on the ground. The diameter of circles will depend on the height of the ball.

The measurement starts in the morning, by marking the ball's shadow each time it crosses a circle. Continue through the afternoon until you have two marks for each circle. These marks are symmetrical with respect to the meridian. Next, draw a line joining the two marks of a given circle and mark the midpoint. The meridian is found by drawing a line from the center of all circles, passing through all midpoints.

## Find the declination of a wall

In the following examples, the Sun's azimuth  $A$  is measured from the meridian (direction of the South when in the northern hemisphere).

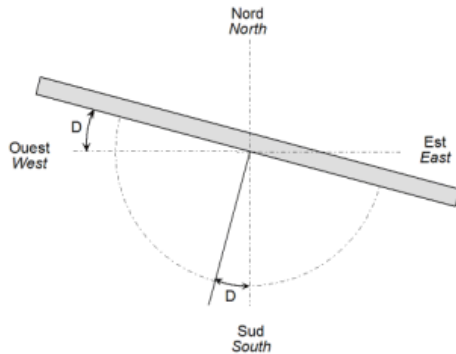

The declination of a wall ( $D$ ) is the angle between the perpendicular axis of the wall and the local meridian. This angle is also found between the wall plane and the East-West axis. The declination is defined as positive towards West and negative towards East. A wall facing South will have a declination of  $0^\circ$  (in the southern hemisphere it will be for a wall facing North). For a wall greatly declining, for example facing North-West, its declination will be between  $90^\circ$  and  $180^\circ$ . A wall facing North is declining by  $180^\circ$ .

In addition to the methods given below, it is also possible to find the direction of the local meridian (see previous section) and to measure the angle between the wall and the meridian (then do not forget to subtract  $90^\circ$  to find the wall declination).

### Method using a protractor and a plumb line

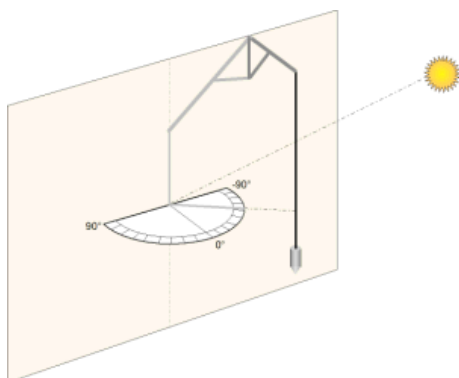

First you need to print the Azimuth circle, from the [Tools menu](#) in Shadows. Cut it in two parts along the East-West diameter and stick it on a semi-circular piece of cardboard.

This protractor is then placed perfectly horizontal, its straight part (diameter) on the wall to be measured. Then, install a plumb line so that its shadow will pass through the center of the protractor.

Write down the angle value ( $L$ ) given on the protractor by the shadow of the thread and the time the measurement was taken. When the Sun is exactly facing the wall, you should obtain a value close to  $0^\circ$ . If you use a classical protractor, subtract  $90^\circ$  from your observation.

In the Ephemeris calculated by Shadows, calculate the azimuth ( $A$ ) of the Sun for that instant.

The wall declination ( $D$ ) is obtained by subtracting the angle ( $L$ ) read on the protractor from the azimuth of the Sun ( $A$ );

$$D = A - L$$

## Method of the chord

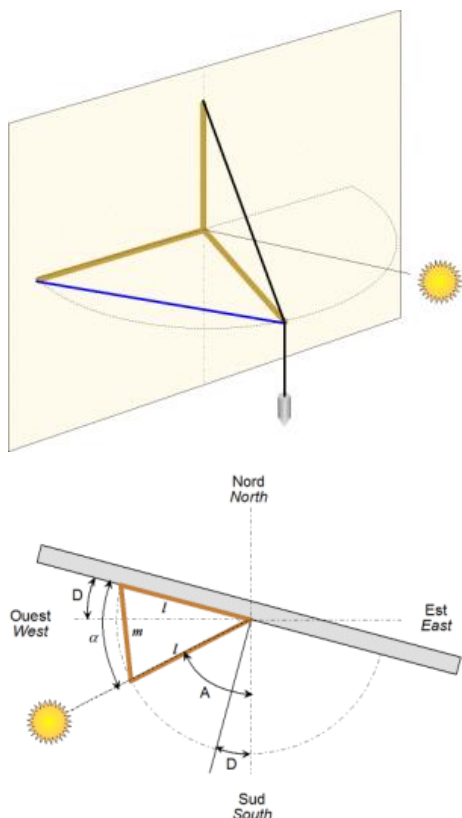

You need to attach two sticks of wood of length ( $l$ ) by a hinge, so that it makes a kind of compass. A third stick is installed perpendicularly to the others, vertically. On its summit, attach the thread of a plumb line. This device can be installed on a horizontal table placed against the wall.

Open the hinge so that one stick stays horizontally against the wall and the other is facing the Sun so that the shadow of the plumb line is passing through the hinge.

With a tape measure, measure the distance ( $m$ ) between the two stick ends.

Calculate the azimuth of the Sun ( $A$ ) in the Shadows Ephemeris for the instant the measurement was taken.

Then calculate the open angle  $\alpha$  between the two sticks:

$$\alpha = 2 \cdot \arcsin ( m / 2l )$$

and finally, calculate the wall declination by:

$$D = \alpha + A - 90^\circ$$

## Method of the oblique shadow

This method is the simplest and only requires waiting until the Sun is passing in the wall plane, so that the light rays are almost parallel to the wall. With the Shadows program, calculate the azimuth of the Sun for that instant. The declination of the wall is then equal to that azimuth augmented by  $90^\circ$  in the morning and diminished by  $90^\circ$  in the afternoon, depending on whether the wall is about to be lit, or about to fall into the shadow.

## Method of the network of tangents

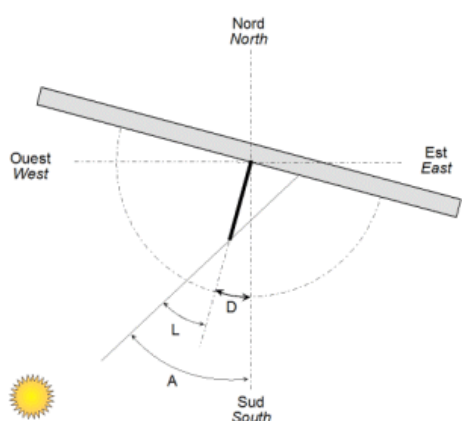

In the Shadows program, you can print a network of tangents ([Tools menu](#)). This network can be used as a tool to help measure the declination of a vertical wall. The paper must lay on the wall, and a style is placed perpendicularly to the sheet, on the  $0^\circ$  line. The length of the actual style must correspond to the value used in Shadows to print the network.

The style casts a shadow on the network of lines, each line being graduated in degrees. This value is the angle between the direction of the Sun and the perpendicular axis of the wall. Record the angle and instant the measurement is taken.

In the Shadows program, calculate the azimuth of the Sun ( $A$ ) at that instant. The wall declination ( $D$ ) is simply given by subtracting the value of the angle ( $L$ ) read on the network from the value of the azimuth ( $A$ );

$$D = A - L$$

It's better to do the measurement when the Sun is not perpendicular to the wall but has an angle of at least  $40^\circ$ .

## Method of circle bisectors

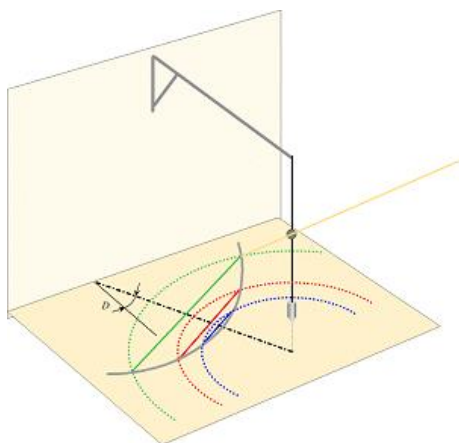

This method is based on the fact that the elevation of the Sun is symmetrical on either side of the meridian. For example, one hour before the meridian, the Sun's altitude is the same as one hour after. Here, we do not need to know the time of the meridian passing as we will find the bisector circles of same height.

Install a plumb line above a sheet of paper placed on a horizontal surface. Add an object on the plumb line between half and 2/3 of its height. Mark the shadow of this object on the paper at various moments in the morning. Draw a series of circles centered on the plumb line and passing through the marks on the paper. Wait until the shadow crosses the circles and mark again these positions. Then draw a line between the two points of given circle. Identify and mark the midpoints. These midpoints are located on the meridian line. Finally, measure the direction of that line with respect to the perpendicular direction to the wall.

## Calculation tool for the determination of the wall declination

This tool can be found in the [Tools menu](#) > [Calculate the declination of a wall...](#) The aim of this tool is to find the declination from measurements made by the user, using one of the proposed measurement methods.

How to use it?

1. [Enter the location](#) in the upper-right frame. By default, this location is set to the reference location defined in the software.
2. [Enter the date and the instant](#) of the measurements.
3. Astronomical data are provided only for information, all calculation are being performed by the software.
4. [Select a measurement method](#) in the left frame under the graphic. Enter the additional parameters as required.
5. [Proceed to the measurements](#) outside and write down accurately the time of each observation. It is recommended to repeat the measurements several times in order to increase the accuracy.
6. When back in front of the computer, enter the series of data one by one in the Data frame, then click on the button Validate. The software calculates the declination from the data and adds the result to the list. An average result is calculated from the list and displayed. The average increases the accuracy by balancing random errors due to the manual measurements.

Once the declination value is obtained, it can be used to design a sundial by entering it as a parameter into the [Create a new Sundial](#) wizard.

## Adjust the size of the sundial

### Size of the sundial plate

The plate is the surface on which the sundial is drawn. It is drawn in Shadows with a frame that can be rectangular, elliptical or polygonal. Its size is defined by its **width** and its **height** that can be changed in the

Configuration menu >  Dimensions...

Two modes can be used in this dialog: The **Manual mode** or the **Automatic mode**. The manual mode allows the user to adjust the width and height of the plate independently as well as the height of the style. The automatic mode adjusts automatically the height of the plate and of the style from the value of the width.

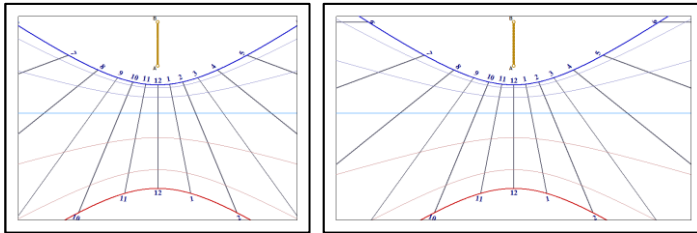

Here the width of the plate is changed. The scale of the drawing is not changed, as the height of the style is the same in both cases.

### Adjust the scale of the drawing

The scale of the drawing is given by the height of the perpendicular style (placed at A). The scale can be changed independently from the size of the frame by using the manual mode and adjusting the height of the style.

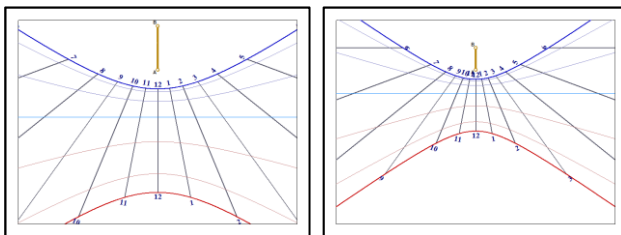

On the right, the style is half the height as the one on the left. The drawing shows more hour lines inside the frame.

### Adjust the anchor of the style

The anchor of the style is the position of point A within the frame. The anchor can be changed from the

Configuration menu >  Style anchor...

Point A can be set as a percentage of the frame width and height, or as a distance from the upper left corner of the frame. In the former case, point A will remain at its relative position when the frame size is changed while in the latter case it will stay at a given distance in millimeters from the corner.

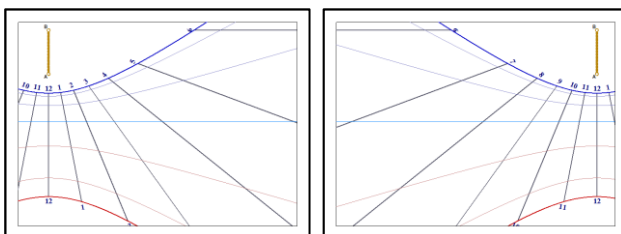

Example showing the effect of changing the anchor horizontally.

The anchor can also be changed from the keyboard using **CTRL-<arrow>**.

### Change the shape of the plate

Shadows offers several geometrical shapes for the sundial plate: rectangular, elliptical or circular, octagonal (rectangular with cut corners) or hexagonal. These settings are available in the toolbar by clicking on the icon



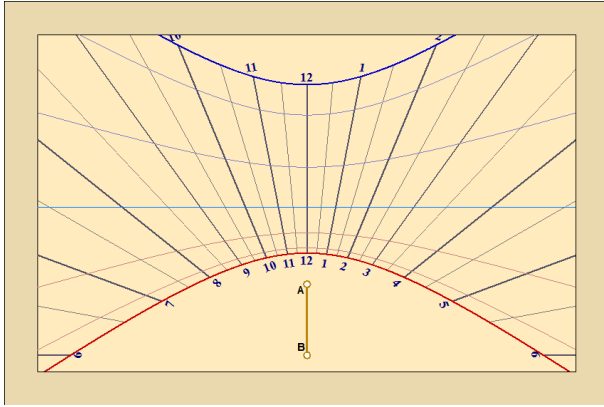

*Rectangular plate*

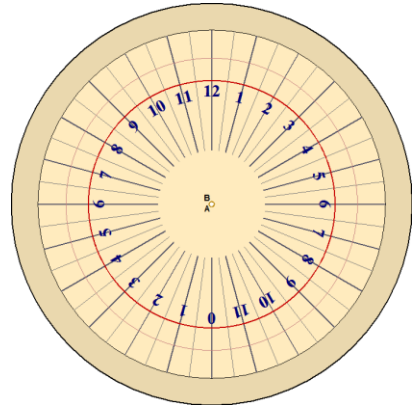

*Circular plate*

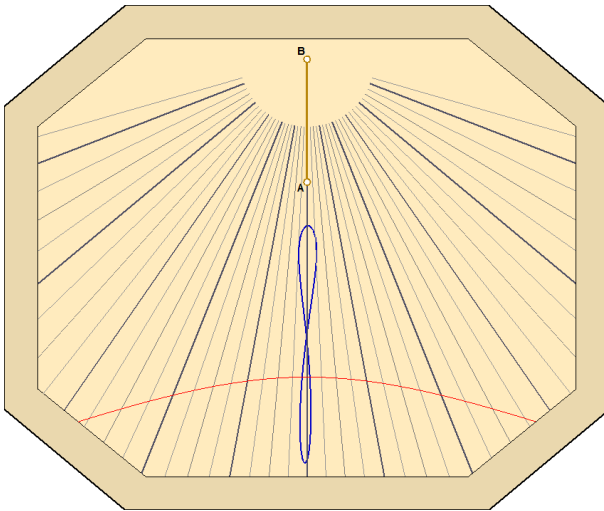

*Octagonal plate*

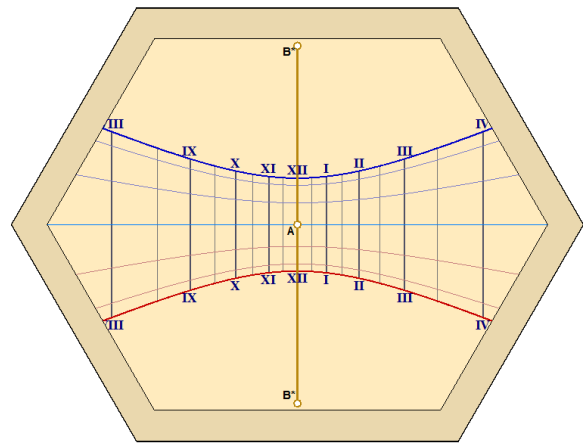

*Hexagonal plate*

## Visualizing and animating the style's shadow

It is possible to visualize the shadow of the style on the sundial as it is at the current moment by selecting the **Tools menu** >  **View the style's shadow**. If the sundial would not be currently illuminated by sunlight, it will appear entirely gray.

It is also possible to visualize the shadow at another time of the day or of the year by selecting the option **Tools menu** > **Animate the style's shadow...**

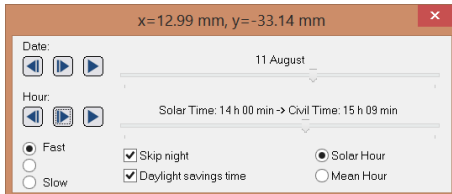

The shadow can be animated for a given instant throughout the year, or throughout the day.

Time can be chosen in solar time or civil time (clock time).

Buttons allow the user to step forward or backward or to start an automatic animation.

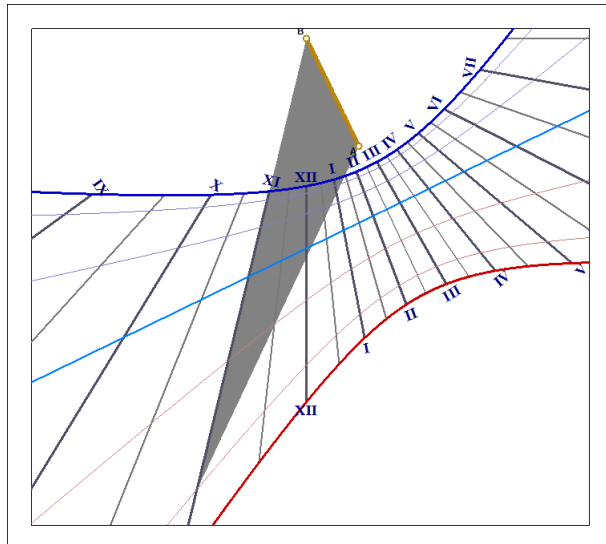

The shape of the style can be changed in the **Tools menu** > **Style shape...** The software changes the shape of the shadow to match the choice. It is also capable of simulating the light spot cast from an **eyepiece** (disk with a hole).

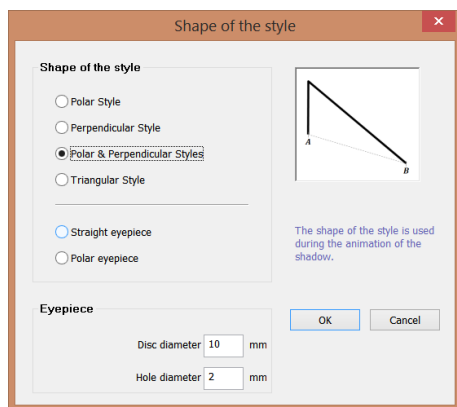

The eyepiece can be configured with the **diameter of the disk** that casts a shadow and the **diameter of the hole** that casts a light spot.

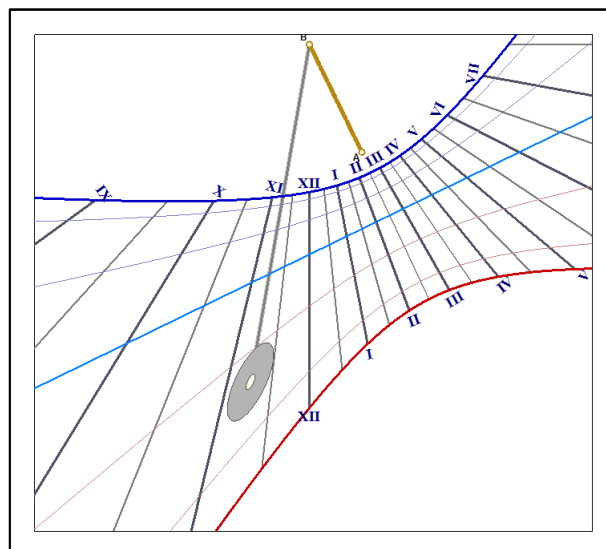

## Visualizing the shadow of a roof

Vertical sundials sometimes turn useless because they are in the shadow of the roof, especially during Summer, when the Sun is high. In order to predict and avoid such event, Shadows offers a simulation tool that displays the shadow of a roof for various moments of the day and of the year. You can therefore verify that your sundial is safe of being in the shadow.

The shadow of the roof is displayed when both options **Animate the style's shadow** and **Show the shadow cast by the roof** are activated.

Two configurations are proposed: the shadow of a horizontal roof (or a balcony), and shadow of a gable roof.

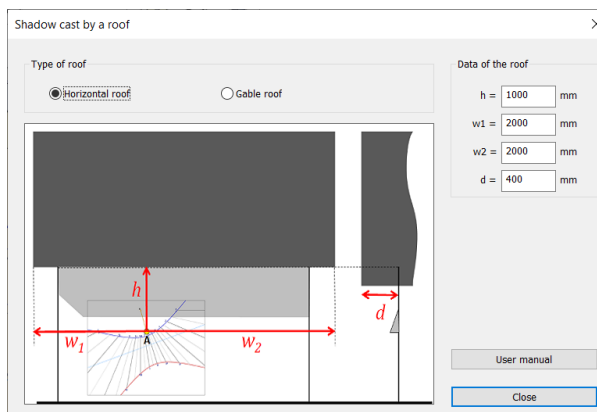

*Configuration of a horizontal roof*

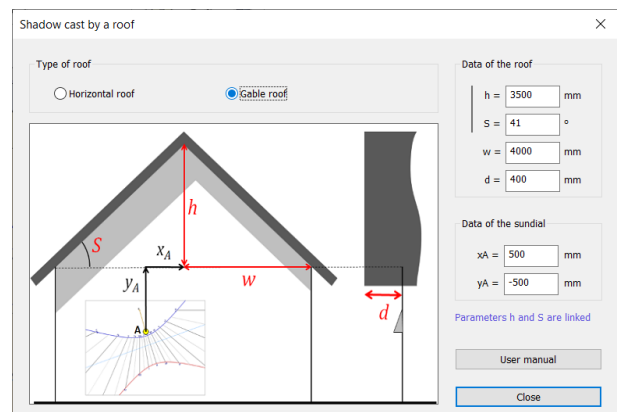

*Configuration of a gable roof*

The roof shadow is displayed on the sundial when the animation of the style's shadow is activated.

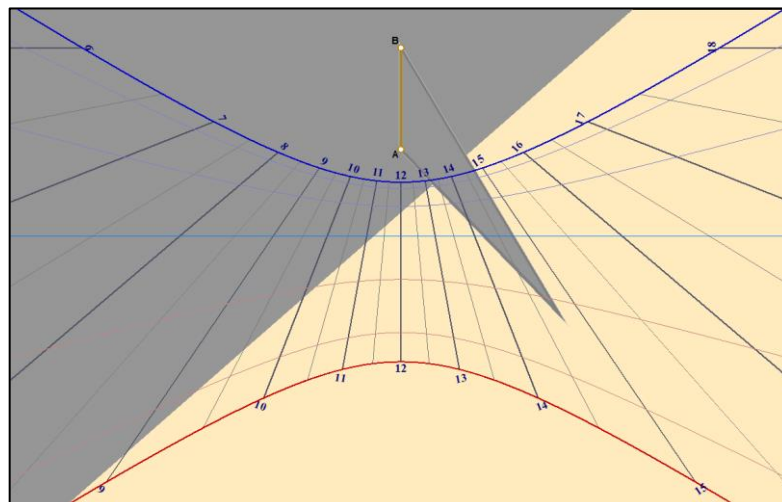



# Indications given by the sundial

## Choose indications

The selection of the type of drawing is done in the

Configuration menu >  Indications given by the sundial

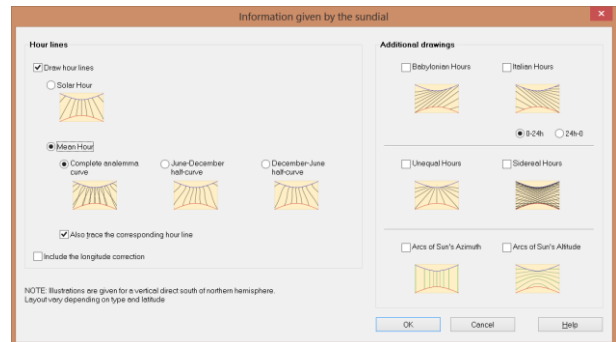

## Local solar time

Local solar time is the time obtained directly from the **hour angle** of the Sun.

In this case, it is noon when the Sun passes through the local meridian (hour angle = 0). The vast majority of sundial display solar time. Solar time depends on the longitude of the location. It will not be the same solar time at the same instant both in Paris and Berlin.

A sundial displaying solar time lines can be easily recognized by the noon line which is vertical (on a vertical sundial).

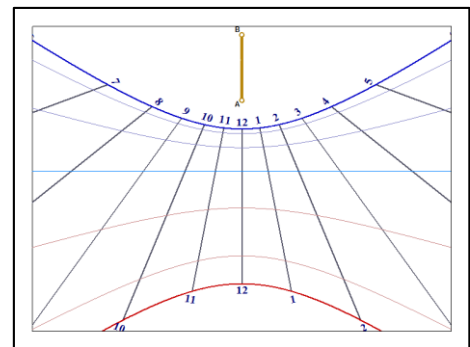

## Solar time of the time zone

Here a longitude correction is applied between the place of the sundial and the reference meridian of the time zone.

To enable it, check the box **Include the longitude correction**.

With this correction, the sundial will display the same solar time as the time zone reference meridian (in Western Europe, UT + 1h), whatever the location of the sundial within this time zone.

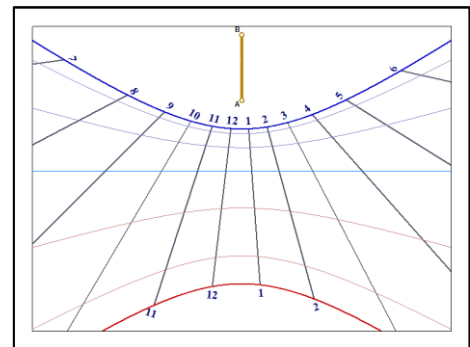

## Mean time (clock time)

The time is corrected with the **equation of time**. If the longitude correction is also included, it gives the civil time, and which is the time given by a clock or a watch. Daylight savings must be added manually if applicable.

The equation of time produces a figure-8 -shaped curve for each hour line. Marks or colors can be added in order to know which side of the curve should be used.

The full curves are difficult to read when too many hour lines are drawn (*e.g.*, when quarter hours are drawn). This is why it is sometimes better to draw only half curves.

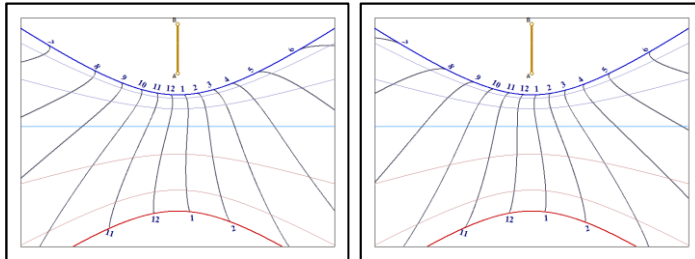
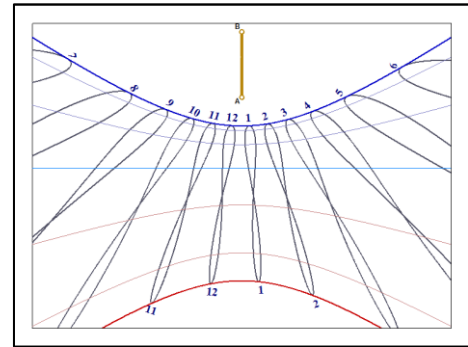

Half curves are drawn between solstices, from June to December or from December to June. One can create two sundials marking mean time, one working each half of the year.

Left: from June to December. Right: December to June.

## Italic hours

Italic hours are counted from sunset the day before. They can be marked from 0 to 24h or 24h to 0; in the latter case, they provide the number of hours until sunset.

Italic hours can be also displayed using the keyboard shortcut **CTRL-i**.

Italic hours are available in [Shadows Expert](#) and [Shadows Pro](#).

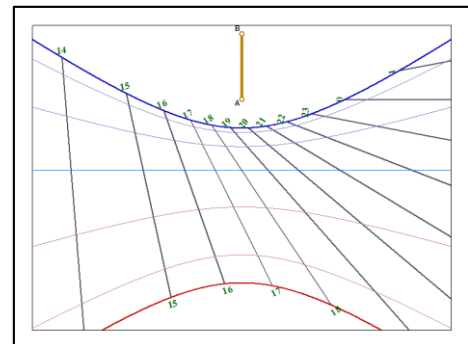

## Babylonian hours

Babylonian hours are counted from sunrise.

Babylonian hours can be displayed using the keyboard shortcut **CTRL-SHIFT-b**.

Babylonian hours are available in [Shadows Expert](#) and [Shadows Pro](#).

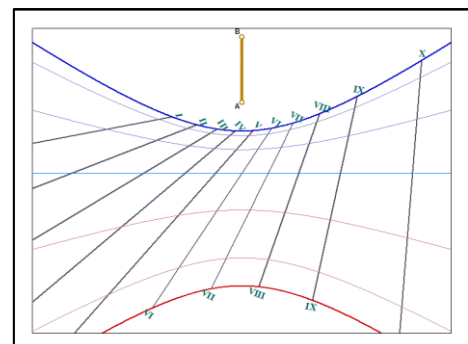

## Unequal hours

Unequal hours are counted 12h from sunrise to sunset.

Depending on the season, these hours vary in length. In Central Europe, they vary from 40 to 80 minutes.

Unequal hour lines are crossing with hour lines on the equinoctial line, as during equinox they have the same length.

Unequal hours are available only in [Shadows Pro](#)

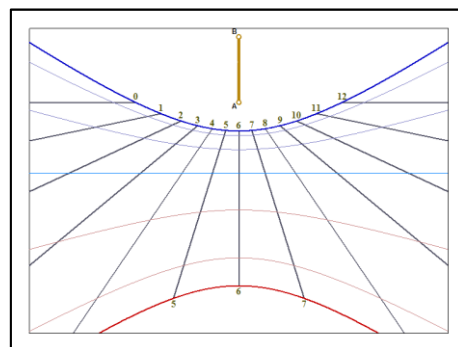

## Sidereal hours

Sidereal hours correspond to the hour angle of the vernal point and are used to locate stars.

Sundials that display this type of hours are quite rare and difficult to read and interpret.

Sidereal hours are available only in [Shadows Pro](#).

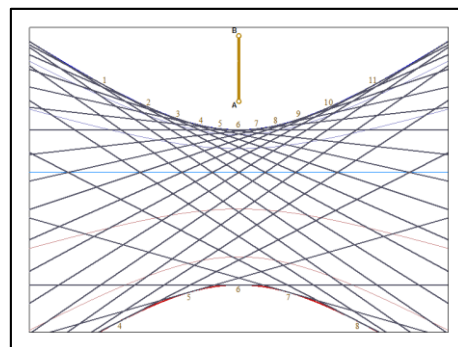

## Azimuth and altitude of the Sun

This option does not draw hour lines but rather curves representing the horizontal coordinates of the Sun. Some sundial will only provide the altitude (such as for the shepherd's dial).

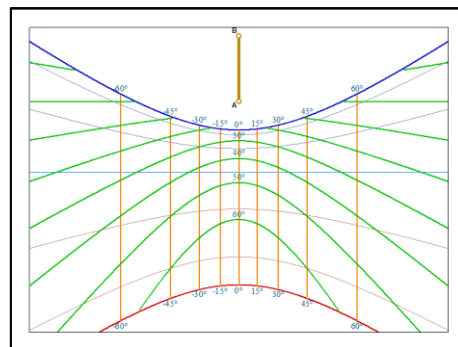

The example on the right shows azimuth lines in orange and altitude arcs in green.

Azimuth and altitude curves are available only in [Shadows Pro](#).



## Analemma curve

It is quite common to see sundials with a figure-8 -shaped curve at noon. It is the analemma curve which is represents a correction (the equation of time) allowing viewers to read mean time as on a watch. To do so, you must also include the longitude correction that has the effect of shifting the curve off the hour line so that it is not vertical anymore (unless the sundial location is right on the reference meridian).

The analemma curve can be displayed from the [Drawings menu](#) >  [Draw analemma](#). And it can be configured from  [Analemma options...](#)

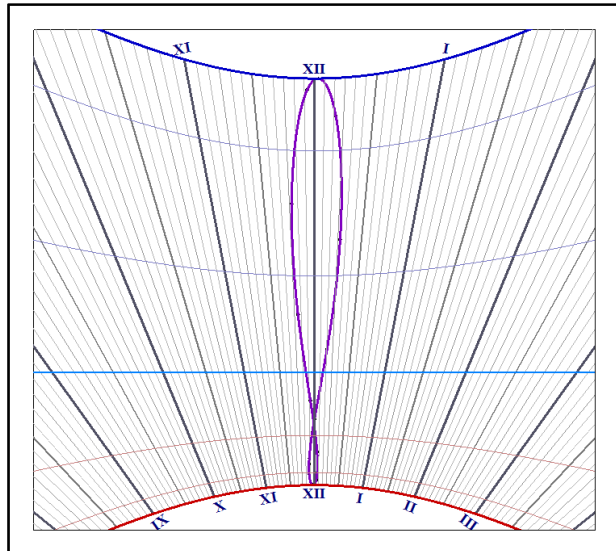
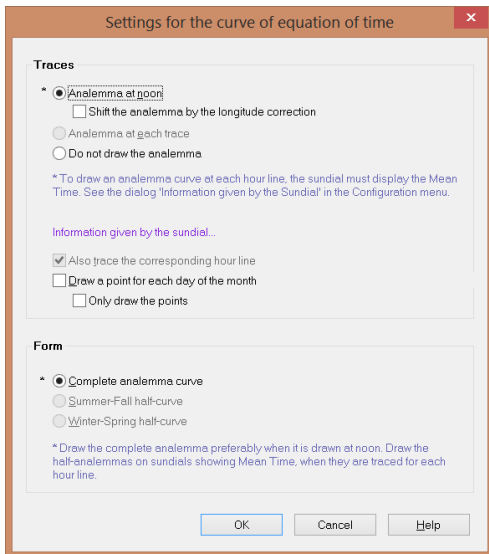

Points can be drawn on the curve in order to indicate the date. A point is drawn for the first day of the month and then every five days thereafter.

## Specific hour lines

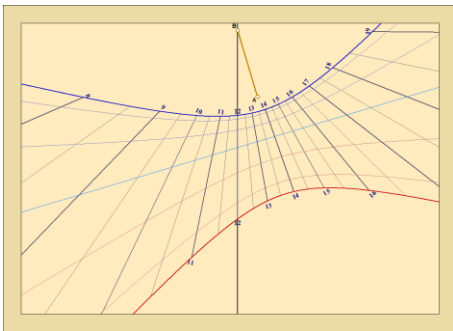

### Solar noon line

The solar noon line can be drawn across the sundial, by selecting the **Drawings** menu > **Draw the solar noon line**.

On a vertical sundial, the solar noon line is always vertical and correspond to 12 hours of solar time.

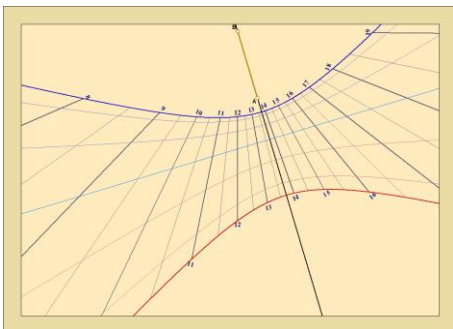

### Sub-style line

The sub-style line can be drawn across the sundial by selecting the **Drawings** menu > **Draw the sub-style line**.

The sub-style line is the line extending the segment A-B of the style. On a declining sundial, this line is inclined.

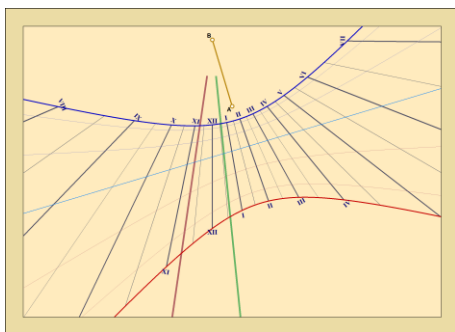



## Noon line for other locations

It is now possible to draw a noon line for different locations.

On the left example, a vertical declining sundial made for Paris, the brown line is the noon line for Berlin and the green line is the noon line for Dublin.

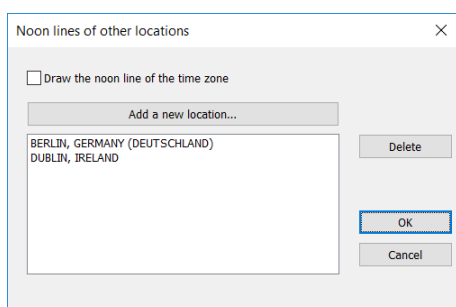
This function is available in **Shadows Expert** and **Shadows Pro**. In **Shadows**, it is only possible to draw the noon line of the reference time zone.



The color and thickness of the lines can be changed in the **Style of lines** dialogs .

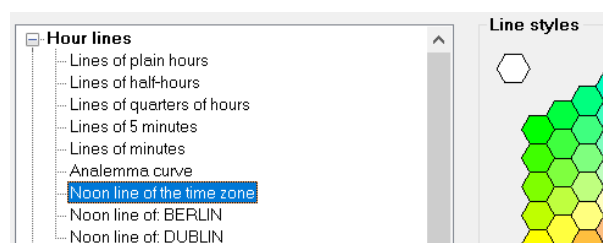

## Declination lines

Declination lines are curves that mark the trajectory of the style shadow during the day.

Several options can be chosen for declination lines. By default, arcs are drawn for each zodiac sign change.

### Arcs related to ecliptic longitude

The trajectory of the apparent Sun (the ecliptic) crosses the celestial equator at two points: the ascending vernal point and the descending vernal point. When the Sun appears at one of those vernal points, it announce the equinox. Historically, the Earth's orbit has been decomposed into twelve sectors of 30° each corresponding to one of the Zodiac signs. A declination arc is usually drawn on a sundial when the apparent Sun changes sectors. Two of these arcs are for the two solstices, another one for the two equinoxes (which are superimposed)

For each sector change, the declination of the Sun can be calculated:

$$0^{\circ} ; +11^{\circ}29' ; +20^{\circ}20' ; +23^{\circ}26' ; +20^{\circ}20' ; +11^{\circ}29' ; 0^{\circ} ; -11^{\circ}29' ; -20^{\circ}20' ; -23^{\circ}26' ; -20^{\circ}20' ; -11^{\circ}29'$$

It is also possible to decompose the orbit into smaller sectors of 10° of ecliptic longitude. These 36 sectors are called decants.

### Arcs related to the declination of the Sun

Because of the inclination of the ecliptic with respect to the celestial equator, the declination of the Sun varies during the year, from 23.45° above to 23.45° below the equatorial plane. It is therefore possible to draw an arc every 10° or every 5° of declination. As the extreme value is not an integer divisor, it is common to draw the solstice's arcs at the same time.

This option is available in **Shadows Expert** and **Shadows Pro**.

### Arcs related to the date

It is also possible to draw arcs for certain intervals of time: every months, every 2 weeks or every 10 days. Though it should be noticed that such arcs do not superimpose each other as for Zodiac arcs. The consequence can be too many arcs that are too close to each other. That's why this option is recommended only for large sundials.

If the sundial displays mean time using half analemma curves, arcs of date will be also limited to half a year, allowing the creation of two complementary sundials, one for winter & spring and another one for summer & fall.

This option is available in [Shadows Expert](#) and [Shadows Pro](#).

### Arcs for particular dates

The trajectory of the shadow on a sundial follows an arc during the day. This option makes it possible to create a custom arc on your sundial for a particular date of the year (in addition to the standard declination lines, if desired). It allows you to mark an anniversary or birth date.

This option can be reached from [Drawings menu](#) > [Anniversary Date...](#)

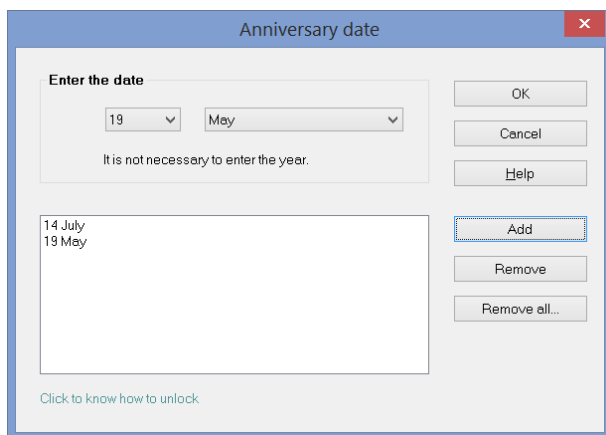

Select a date using the lists and click on the button [Add](#).

The freeware level of [Shadows](#) allows only one date at a time, while [Shadows Expert](#) and [Shadows Pro](#) allow an unlimited number of dates.

### Coloring the background outside solstice arcs

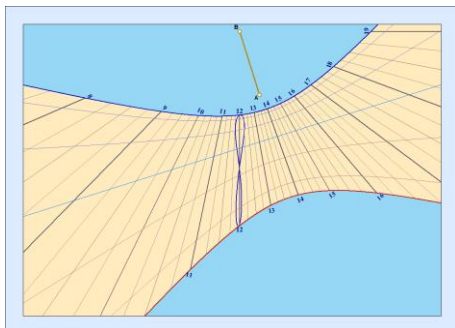

A new option in the preference [Sundial layout](#) allows the coloring of the sundial background, outside the solstice arcs, using a specific color.

The area in between the solstice arcs is still filled with the sundial background color selected in the preference [Sundial plate](#).

This option is only available in [Shadows Pro](#).

### Coloring the background between declination arcs

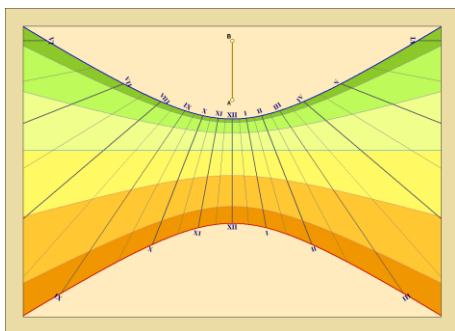

Another option allows the coloring of the sundial background between Zodiacal declination arcs, or between equinoxes and solstices arcs.

Predefined sets of colors are proposed in the Preferences. In case the option to colorize between equinoxes and solstices is selected, the lighter color of the selected color set is used.

To select colors, click on the icon  [Sundial layout](#).

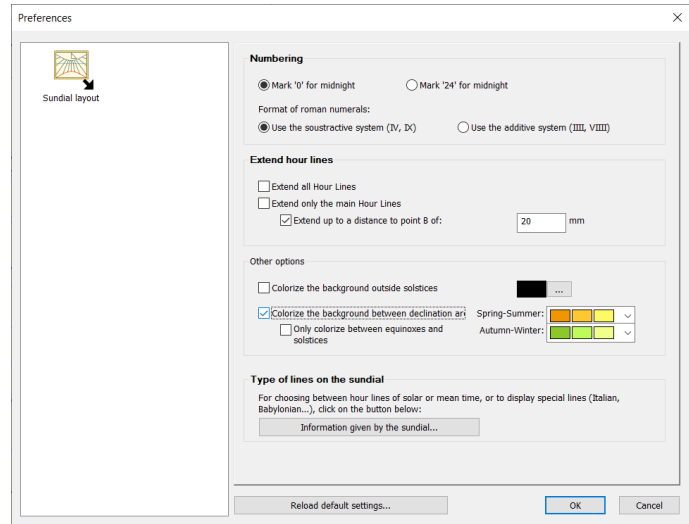
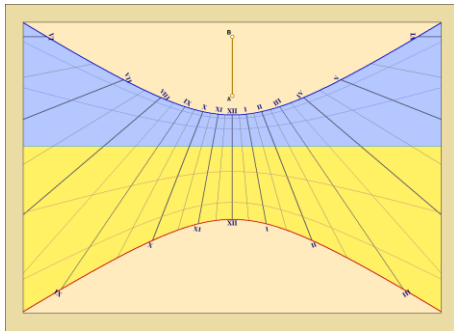

This option is only available in **Shadows Pro**.

## Change the style and color of drawings

The color and thickness of lines in drawings can be modified from the **Drawings menu** >  **Style of lines...**

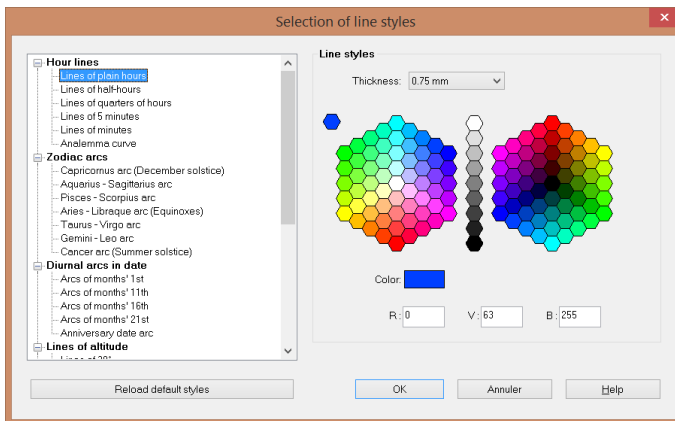









Click on the name of a drawing element in the left list and change its thickness from the roll over list, and its color by clicking on a cell of the color picker.

Alternatively, the color components can be entered manually as R (red), G (green) and B (blue) values.

## Changing other attributes on the sundial

The sundial view is configured using the **Drawings menu** and using icons of the toolbar

-  Allows the modification of options for the sundial plate, such as using a rectangular, circular, hexagonal or octagonal shape, or drawing a double frame, or choosing the background color.
-  Allows the modifications of drawing options, such as extending hour lines, or selecting the numeral format
-  Limitation of the hour span (for example between 8 h and 14 h)
-  Draw / hide hour numerals
-  Use 24 h or 12 h format
-  Use Roman or Arabic numerals for hours
-  Draw hour lines of 30 minutes
-  Draw hour lines of 15 minute
-  Draw hour lines of 5 minutes



Draw hour lines every minutes. Should be used only on very large sundials



Selection of the font and size of text used for hour numerals



Draw the analemma curve at noon



Options for the analemma curve



Draw / hide declination arcs



Options for declination arcs



Style of drawing lines



Mark the position of the style with letters A and B



Draw X-Y axes on the sundial origin

Draw the sub-style line. Useful on declining sundial

Draw the solar noon line

Draw the noon line for the reference time zone. Includes the longitude correction

Draw lines only when the Sun illuminates the sundial

Extend hour lines to the plate edges

Extend all hour lines to the plate edges



Draw flatten down style. Visualize its size on the sundial



Draw the construction layout. This layout is the ancient way to draw hour lines

## Decorate the sundial

A sundial is not just a set of lines. It should also be well decorated and perhaps have a philosophical motto. The decoration may be part of the drawing, around the perimeter, or both.

The first step is the frame, that can have a border or not. It is quite common to find drawings of animals or plants around the polar style (point B), or graphical representation of Sun.



*This morning sundial, located in the Pragelato valley near Sestriere in Italy, leaves more space for the decoration than for the sundial layout. The style is realized by the ski stick. The motto is in Piemontese dialect.*



*This other sundial, located in Serre-Chevalier, France, also leaves a large area for the decoration, and the motto is written in a complex series of curves. Again, the sundial layout is simple to emphasize the beauty of the painting. It's a real artistic creation.*

The detailed description of decoration techniques is out of the scope of this manual, but the flexibility of the Shadows software allows for many possibilities.

In Shadows, it is possible to insert a vector drawing or an image that can be printed with the sundial. Vector format is preferred as it can provide a helpful guide when drawing the outline of the decoration during construction.

### Add some text

Text frames can be placed on the sundial in order to add labels, symbols, etc. Text font and size can be modified. Typically, text frames are used to label hour lines and other types of lines, or add mottoes and geographical coordinates.

Insert a text frame from the [Frame menu](#) >  [Insert a text frame...](#) It can contain the following information:

- Free text entered by the user
- A motto chosen from a predefined list
- A Zodiac symbol
- The name of the location
- The type of sundial
- The geographical coordinates

The text font, size and color can be modified.

## Add a motto

The motto of a sundial is often the part that we remember. It expresses the place of mankind in the universe: regarding time, regarding death or regarding God. The motto is often philosophical, sometimes religious, and usually contain a double meaning. Do not hesitate to add a motto on your sundials by choosing one from the list of mottoes included in Shadows, taken from a book, a favorite poem or even from you own inspiration. The motto is a statement you wish to make with your sundial.

Mottoes are inserted through text frames. Shadows comes with more than 550 mottoes in English, Latin, French, German, Italian and other languages.

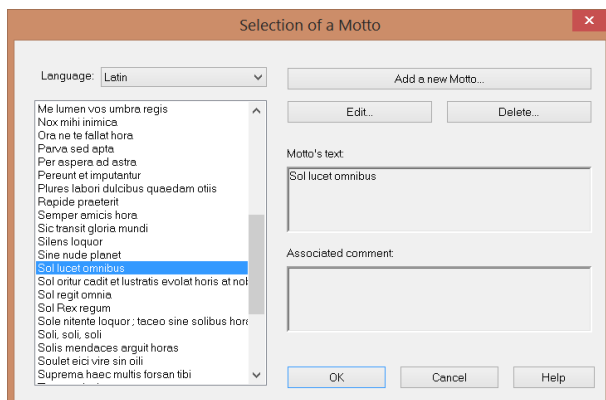

Select a motto from the list. You can modify it or add a comment (usually a translation). The comment will not be displayed on the sundial.

Mottoes are stored in a file, [mottoes.txt](#) located in the installation folder of Shadows.

## Import an image

Insert an image frame from the [Frame menu](#) >  [Insert an image frame ...](#)

Image frames can contain and display files in the following image formats:

- Windows BMP bitmaps
- GIF bitmaps, either transparent or opaque, in 16 or 256 colors.
- JPG bitmaps in 16 bits.
- WMF or EMF vector drawings

Bitmap images are made of pixels; they can be used for pictures and photos. Drawings are made of lines and geometrical shapes; they can be used for symbols and stylized drawings.

You may prepare the image in the software program of your choice, save it in one of the formats above and then import it into Shadows. Alternatively, you can scan an image in a book or make a custom drawing using vector drawing software.

Examples of vector cliparts are included with Shadows, in the sub-folder [cliparts](#) of the installation folder.

Image frames are available in [Shadows Expert](#) and [Shadows Pro](#).

## Export drawings

### Copy-paste the view into another software

This option creates an image of the displayed view. It can be copied either as bitmap image or a vector drawing. The latter option is recommended for curves and line drawings because they can be scaled without showing pixels, and each part of the drawing can be modified individually.

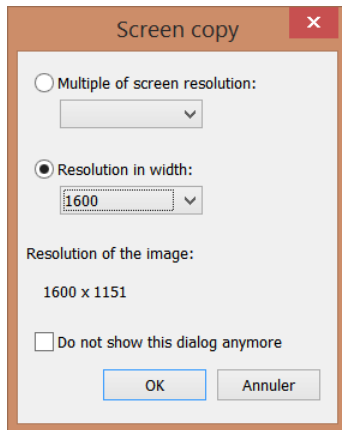

When copying the view as a bitmap image, you can select the resolution in a dialog, or in the [Preferences](#).

The resolution can be a multiple of the screen resolution (*e.g.*, x1 or x4) or set as a fixed width in pixels (from 640 to 3000), the height in this case is calculated from the image aspect ratio.

The image is placed into the memory and is ready to be pasted into another program.

Keyboard shortcuts: **CTRL-C** to copy as a bitmap image, **SHIFT-CTRL-C** to copy as a vector drawing.

The copy in bitmap format  is available in all levels.

The copy in vector format  is available in [Shadows Expert](#) and [Shadows Pro](#).

## Export a vector drawing

### Export in EMF

This feature will create a file (with the extension `.emf`) containing the current view as a vector drawing in [Enhanced Windows MetaFile](#) format. This file format is compatible with most drawing programs and word processors.

You can then modify any part of the drawing (*e.g.*, the curve representing the equation of time) in a third-party program. Some programs are able to drive engraving machines from a vector drawing, or even machine tools.

EMF export is available in [Shadows Expert](#) and [Shadows Pro](#).

### Export in DXF (CAD software)

The drawing can be exported in DXF format from [AutoCAD](#). Most CAD programs support this format as do programs that can drive machine tools. This format contains a series of ASCII codes that describe the sundial drawing. It can be loaded and modified in a text editor.

Only drawings are exported in DXF and some automatic texts, but not text and images contained in frames. If you want to have the complete drawing, use the EMF export.

The DXF format has many variations and some programs may not load or will interpret differently the DXF file generated by Shadows. In case of problem you may contact the author to try to find a solution or add new options to support the variant.

DXF export is available in [Shadows Pro](#).

## Tables of coordinates

Tables of coordinates are generated as tab-delimited text files that can be loaded into a text editor or a spreadsheet program (*e.g.*, Excel). Tables of coordinates are generated from the [Configuration menu](#) > [Tables of coordinates](#).

## Coordinates of hour lines

	A	B	C	D	E	F	G	H
1	CO-ORDINATES OF HOUR LINES							
2	Origin of the (x, y) co-ordinates: point A.							
3	Origin of the (radius, angle) co-ordinates: point B.							
4	Hour	Min	Day	Month	X (mm)	Y (mm)	Radius (mm)	Angle(°)
5	6	30	17		3 -493.03	58.68	499.69	-9.36
6	6	30	22		3 -338.52	33.19	343.09	-9.36
7	6	30	27		3 -258.00	19.92	261.49	-9.36
8	6	30	1		4 -208.75	11.79	211.57	-9.36
9	6	30	6		4 -175.64	6.33	178.01	-9.36
10	6	30	11		4 -151.95	2.43	154.00	-9.36
11	6	30	16		4 -134.24	-0.50	136.05	-9.36
12	6	30	21		4 -120.58	-2.75	122.21	-9.36
13	6	30	26		4 -109.80	-4.53	111.28	-9.36
14	6	30	1		5 -101.15	-5.95	102.52	-9.36
15	6	30	6		5 -94.13	-7.11	95.40	-9.36
16	6	30	11		5 -88.39	-8.06	89.59	-9.36

The number of lines in the table depends on the number of hour lines drawn on the sundial (½ hours, ¼ hours, etc.) Each hour line is described by a point every 5 days. When a point is outside the frame, it is noted with a star symbol.

## Coordinates of declination lines

	A	B	C	D	E	F
1	CO-ORDINATES OF DECLINATION LINES					
2						
3						
4	Cancer	(23.44°)				
5	h	min	x (mm)	y (mm)	radius (mm)	angle (°)
6	4		0 -577.83	-440.54	726.61	37.3
7	4		30 -239.72	-147.02	281.21	31.5
8	5		0 -152.34	-73.77	169.26	25.8
9	5		30 -111.19	-40.97	118.50	20.2
10	6		0 -86.68	-22.63	89.59	14.6
11	6		30 -70.03	-11.08	70.90	9.0
12	7		0 -57.73	-3.26	57.82	3.2
13	7		30 -48.07	2.31	48.13	-2.7
14	8		0 -40.14	6.40	40.65	-9.1

Each arc of declination is described by series of points corresponding to hour lines. The name of the arc is given before values. It may be a Zodiac arc or decant, it can be for a given date or declination, depending on the choice made in the [Drawings menu](#) >  Declination lines options...

## Coordinates of analemma curves

	A	B	C	D	E	F
1	CO-ORDINATES OF ANALEMMA CURVES					
2						
3						
4	5 h					
5	day	month	x (mm)	y (mm)	radius (mm)	angle (°)
6	26	IV	-734.23	-259.71	778.81	19.5
7	1	V	-449.64	-165.96	479.29	20.3
8	6	V	-330.66	-127.09	354.25	21.0
9	11	V	-266.27	-106.35	286.73	21.8
10	16	V	-226.70	-93.89	245.37	22.5
11	21	V	-200.62	-85.94	218.25	23.2
12	26	V	-182.82	-80.79	199.87	23.8
13	1	VI	-168.67	-77.06	185.44	24.6
14	6	VI	-161.19	-75.43	177.96	25.1

Points along the analemma curve are given every 5 days. It is used either for the analemma at noon or for mean time sundials with each hour line drawn as a complete or half analemma curve.

## Coordinates of hour points (analemmatic sundials)

	A	B	C	D	E	F
1	CO-ORDINATES OF HOUR POINTS					
2	Origin of the (x, y) co-ordinates: point A.					
3	Hour	Min	X (mm)	Y (mm)	Radius (mm)	Angle(°)
4	4		0 -43.30	-19.96	47.68	24.7
5	4		30 -46.19	-15.27	48.65	18.3
6	5		0 -48.30	-10.33	49.39	12.1
7	5		30 -49.57	-5.21	49.85	6.0
8	6		0 -50.00	0.00	50.00	0.0
9	6		30 -49.57	5.21	49.85	-6.0
10	7		0 -48.30	10.33	49.39	-12.1
11	7		30 -46.19	15.27	48.65	-18.3
12	8		0 -43.30	19.96	47.68	-24.7

The ellipse of an analemmatic sundial is described with hour points, with the same number of points as on screen.

## Coordinates of the mobile style (analemmatic sundials)

Allows the drawing of the date line in the middle of an analemmatic sundial.

	A	B	C	D	E
1	TABLE OF POSITIONS OF THE MOBILE STYLE				
2	Angle between equinoxial and solar noon: -90°				
3					
4					
5		dec (°)	X (mm)	Y (mm)	
6	Cancer	23.439		0 13.06	
7	Leo-Gemini	20.151		0 11.05	
8	Virgo-Taurus	11.472		0 6.111	
9	Libraque-Arie	0.000		0 0	
10	Scorpius-Pisce	-11.472		0 -6.111	
11	Sagittarius-Aq	-20.151		0 -11.05	
12	Capricornus	-23.439		0 -13.06	

## Coordinates of hour lines on the equinoctial line

	A	B	C	D	E
1	CO-ORDINATES OF HOUR LINES ON THE EQUINOXIAL LINE				
2	Angle between equinoxial and solar noon: -90°				
3	Distance between points O and B: 62.01 mm				
4	Distances are given in mm from point O on the equinoxial line.				
5	Hour	Min	Distance O (m) Distance S (mm)		
6	6	30	-361.14	-361.14	
7	7	0	-181.53	-181.53	
8	7	30	-118.33	-118.33	
9	8	0	-85.22	-85.22	
10	8	30	-64.26	-64.26	
11	9	0	-49.38	-49.38	
12	9	30	-37.92	-37.92	

This table provides intersection points between hour lines and the equinoctial line, as drawn on the equinoctial ruler.

Distances are given from point O (solar noon line) or from point S (sub-style).

## Coordinates of special lines

	A	B	C	D	E	F
1	COORDINATES OF THE BABYLONIC HOUR LINES					
2	Origin of the (x, y) co-ordinates: point A.					
3	Hour	Minutes	X1 (mm)	Y1 (mm)	X2 (mm)	Y2 (mm)
4	1	0	-202.18	-115.19	-166.29	226.29
5	1	30	-136.21	-60.70	-99.12	172.84
6	2	0	-102.05	-33.99	-63.19	147.70
7	2	30	-80.66	-18.36	-39.31	134.26
8	3	0	-65.68	-8.24	-20.92	127.14
9	3	30	-54.37	-1.26	-4.96	124.24
10	4	0	-45.35	3.77	10.46	124.85
11	4	30	-37.85	7.48	27.02	129.10
12	5	0	-31.40	10.29	46.90	138.11
13	5	30	-25.70	12.41	73.96	154.78

As for hour lines, coordinates of points for Babylonian, Italic, sidereal, unequal and azimuth and altitude lines are given.

## Constructing the sundial

### Choose a material

In the case of a sundial prepared on a plate that is later installed at its final place, light materials can be chosen to allow easy transportation and lifting, unless it is made with mosaic.

The most frequently used and practical materials are:

- **Wood:** Preferably laminated with a waterproof treatment to resist bad weather. You will probably use wood for your first sundials. You could also use a composite wood made of small particles aggregated under high pressure (*e.g.*, the MDF). This kind of material, often called chipboard, is sometimes used to build office furniture or hi-fi speakers.
- **Tiles:** You can find tiles of up to 50 cm in gardening shops. They are often reasonably priced and have a surface made of some kind of composite material (like chalk, or marble). The surface shouldn't be too irregular. There are special paints that harden in an oven which make it easy to construct a beautiful little sundial using this material.
- **Marble:** Use this only for small sundials because of the weight and cost. Lines can be engraved by sanding. Protect the part that are not engraved with a negative mask.
- **Glass:** Choose a sheet of security, smoked or matt glass which is thick enough to be not too fragile. The lines can be engraved or painted.
- **Plexiglas:** Lighter than glass and very interesting to work with, but is more prone to scratching.
- **Metal:** Sheets of iron, copper or aluminum can all be engraved and enhanced with oxidation, colors or enamel.

It is also possible to cast and use a resin color that when hardened can be painted to look like wood or metal. The advantage of casting a sundial is that you can create several dials using the same mold. The mold can be made of silicon-rubber for example, to make it easier to get the dial out of the mold.

### Transfer the drawing on the material

Shadows can print the dial on several sheets which can be reassembled in order to get a full-scale model.

For dials of reasonable sizes (up to 60 cm each side) you can paste the paper dial on the background and mark every point with an awl. After that you can trace the lines by connecting the points and engrave and/or paint them.

Painted sundials may use the technique of a fresco painting on a wet undercoat. This technique is very difficult to master because you need to work quickly and without any errors. The materials are the same as used for frescos and covering walls: wet chalk and mineral pigments. All the old dials were painted using this technique and they survive quite a long time before they have to be restored. Avoid classic mural paintings because they will not last long enough and have to be restored about every five years.

In the case of a fresco-painted dial you can cut the lines to a width of 1mm to make a stencil, and use a sponge with pigment powder to apply the lines. The pigment will be transferred to the wet base at the same positions as the lines. Then you only have to paint the lines along the sketches. It is also easy to draw straight lines with paint by installing rubber tape on both side of the line separated by the line thickness.

For a large dial, it is advisable to work from a table of coordinates and draw lines using a ruler, a divider calipers (compass) and a protractor.

### Use the equinoctial ruler

This ruler provides a quick way to draw the hour lines. Access to it from the [Configuration menu](#) >  [Equinoctial ruler](#) and print it.

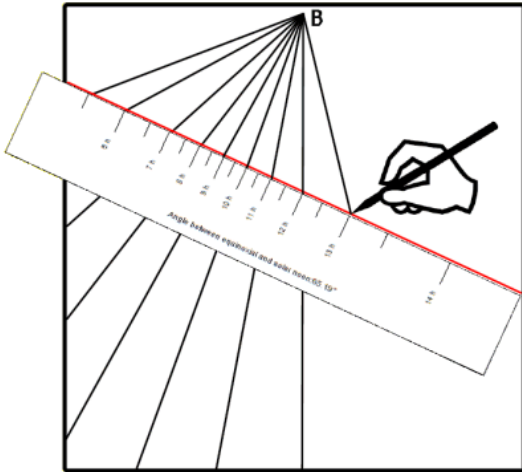

To use this ruler, you place the point B and then draw the solar noon line through this point. Then add the equinoctial line (in red below) using the angle between the equinoctial line and the noon line.

Trace a line between point B and each graduation of the ruler. Positive values are on the right side of the noon line, negative values on the left side. It is much simpler than plotting the coordinates of each hour line from the table of coordinates.

Points on the ruler can be exported to an Excel file. It provides distances from point O and hour lines on the equinoctial line. Point O is defined as the intersection between the solar noon line and the equinoctial line.

On some sundials, the ruler and table cannot be used, either because the equinoctial line is not visible or because point B is too far outside the sundial plate.

### Step-by-step procedure

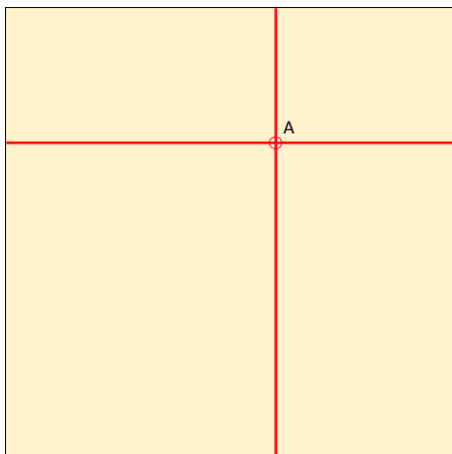

Choose the material you want to use for the sundial plate, on which you will draw the sundial layout (tiles, wood, stone, metal, etc.)

In our example, the plate size will be 150 x 150 cm. The sundial is designed with Shadows at scale 1/10, i.e. 150 x 150 mm. All measures given by Shadows will then be multiplied by 10.

**Step 1.** Place the sundial origin (point A) somewhere on the plate.

**Step 2.** Draw a vertical and a horizontal line from this point.

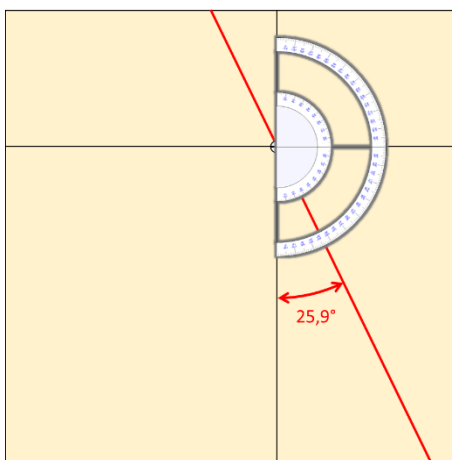

If the sundial is declining, draw the sub-style line:

**Step 3.** Measure the sub-style angle given by the sundial technical data sheet in Shadows, with a protractor.

Here in our example, it is 25,9° (measured from the vertical)

If the sundial is not declining, then the sub-style line will be vertical (angle of 0°)

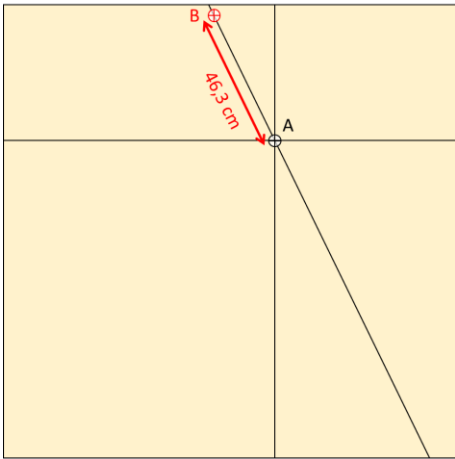

**Step 4.** Mark point B by measuring the distance A-B (length of the style base) along the sub-style line.

In this example: A-B = 46,3 cm

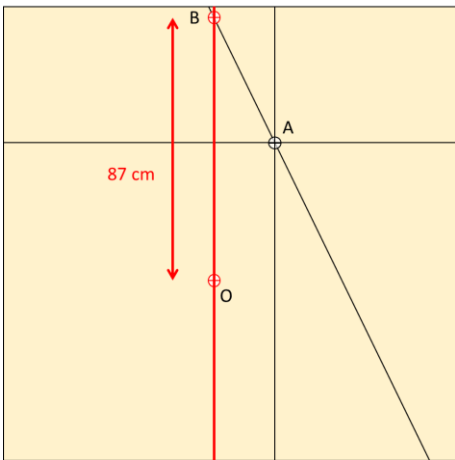

**Step 5.** Draw a vertical line from point B.

**Step 6.** Mark point O by measuring the distance B-O given on the equinoctial ruler.

Point O corresponds to the intersection between the equinoctial line and the solar noon line.

In this example: B-O = 87 cm

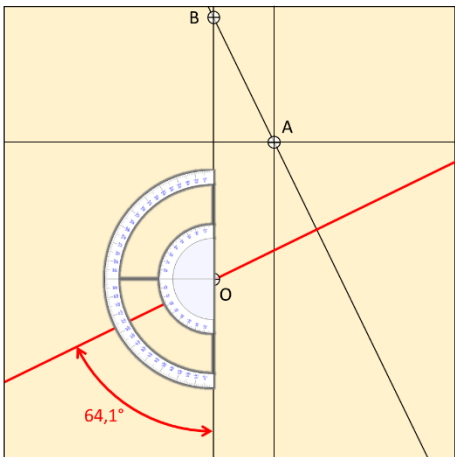

**Step 7.** Draw the equinoctial line from O using the equinoctial angle given on the ruler.

In this example: 64,1° (measured from the vertical)

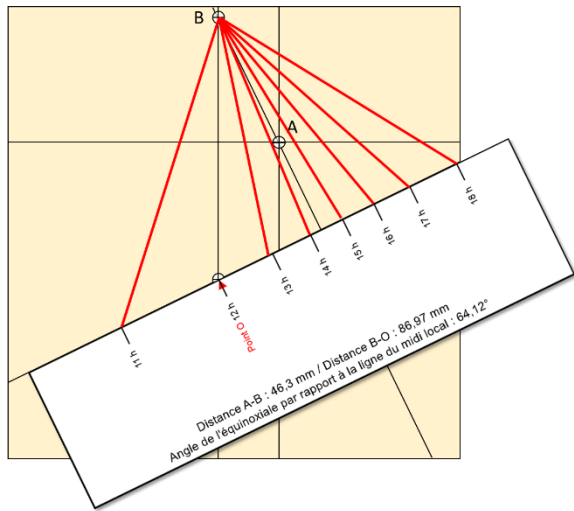

**Step 8.** Print the equinoctial ruler on strong paper and cut it. Place the ruler along the equinoctial line, and align point O with the vertical line passing through B.

Note: dimensions given by Shadows are to be multiplied by 10 to convert mm to cm, i.e. to pass from the mock-up at scale 1/10 to the full scale sundial.

**Step 9.** Draw the hour lines by joining point B to each mark on the ruler.

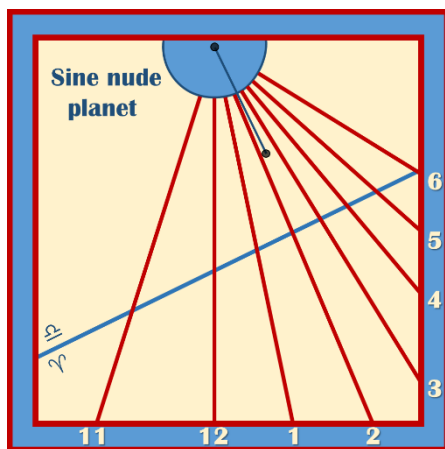

**Step 10.** Extend hour lines to the edges, then decorate the sundial and remove intermediate lines.

Your sundial is now finished.

## Create a large sundial

With Shadows, you can create a sundial of any size by setting the width and height of the plate and the height of the style from  **Dimensions**. On very large sundials it is not advisable to print the drawing to scale as it will likely consume too many pages of paper. In this case, the use of coordinate tables is preferable. During the design phase, it is good to see the sundial on screen, but above 2 or 3 meters of size, you may experience spurious lines on the drawing, as coordinates are getting too large for the drawing on screen.

The solution then is to create a reduced version of the sundial at 1/4 or 1/10 of the full scale. All dimensions are then to be divided by this ratio to get back to the real scale.

For example, an horizontal sundial of 10 m x 4 m, with a style height of 1.50 m, may be modelled on screen at 1/10 by entering 1000 mm x 400 mm for the table dimension and 150 mm for the style height. Then multiply all x, y coordinates given by Shadows by 10 to build the real sundial. Angles can be used directly as they do not change with scale.

## Draw the construction layout

The construction layout visualizes the graphical method of a sundial used in the past by sundial makers until electronic calculators became common. This layout requires only a ruler, a pair of divider calipers (compass) and a protractor.

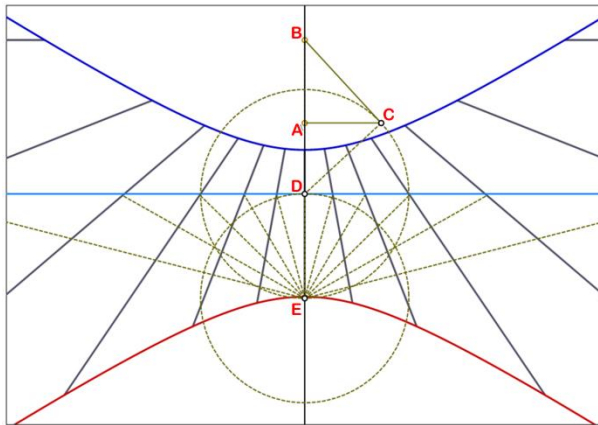

First draw the sub-style passing through points A and B. Then draw the segment A-C perpendicularly with a length equaling the style height.

Next draw a line perpendicular to B-C to create point D on the sub-style line. This point belongs to the equinoctial line. From D, draw a circle with a radius equal to the length of the segment D-C. The lower intersection of the circle with the sub-style line give point E.

Then, draw another circle centered on E with a radius equal to the length of the segment E-D.

From E-D, draw line segments every  $15^\circ$  and extend them until they cross the equinoctial line. Then hour lines can be constructed from point B to these intersections.

If you want to draw  $\frac{1}{2}$  hours, draw segments every  $7.5^\circ$  ( $15^\circ/2$ ), and for  $\frac{1}{4}$  hours use angles of  $3.75^\circ$  ( $15^\circ/4$ ), etc.

## Draw the sundial lines directly from the Sun?

Some people naively think that they can draw a sundial by installing the style in its final position and simply draw the position of the shadow every hour. Simply said... it does not work! In reality, to get the correct layout using this method, you need to be located exactly on the local meridian line and you need to do the drawing on one of the four days where the equation of time is zero: April 15<sup>th</sup>, June 13<sup>th</sup>, September 1<sup>st</sup> or December 25<sup>th</sup>.

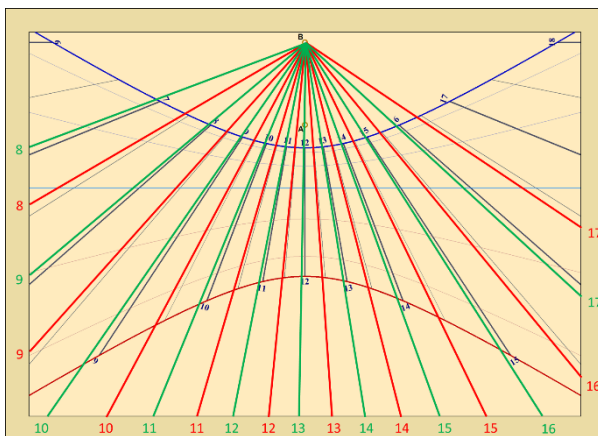

On the example here, a sundial is drawn for Paris. Red lines are drawn from the style shadow on October 21<sup>st</sup>, and green lines are drawn on February 21<sup>st</sup>.

We can see the large deviation between these layouts, both different from the correct layout (in black) which corresponds to solar time lines, normally expected.

The best solution to draw a sundial using the Sun, is to calculate, for the given date, the civil time corresponding to each solar hour line. Then, the mark done from the style shadow at each calculated civil time (noted on your watch) will give the correct position of the solar hour line.

Civil time can be calculated using the Ephemeris in Shadows, or by doing the calculation by hand, following the procedure explained in the section [How to read time on a sundial?](#)

## Build the style

In Shadows, the style position is marked on the sundial with points A and B.

Point A corresponds to the **perpendicular style** (also known as the **gnomon**). Point B corresponds to the **polar style**, when it exists. When this point is rejected for being too far from point A, then the style length is truncated to point B\*.

### Schematics of the style

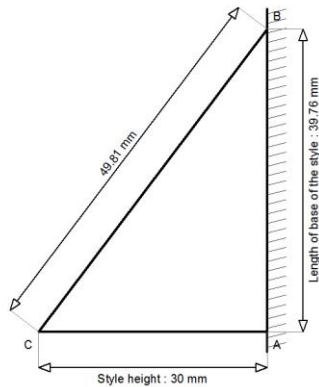

Co-ordinates of the points A and B of the style: A (0, 0) B (0 mm, 39.76 mm) ; (39.76 mm, 90°)

This drawing is available from the **Configuration menu** >  **Schematics of the style**. The style is not drawn to scale but as a scaled drawing showing dimensions and angles. The style height (A-C) and the style length (A-B) are given, as well as the positions of points A and B in the Cartesian coordinate system used on the sundial.

Point C is the end point of the style, where sometimes a ball or an eyepiece is attached.

In case you need to draw the style to scale, go to the **Configuration menu** >  **Drawing of the style**. It will be possible then to use this print out to cut the style on wood or another material.

The style can be cut from the triangular shape but also it can be constructed using a rod or any decorated variation as long as B-C and A-C are of the correct length.

### The triangular style

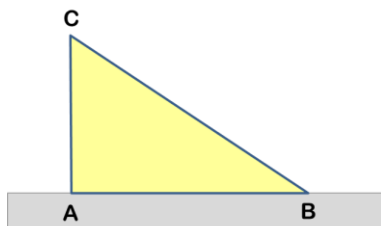

It is the simplest style as it is printed by Shadows. Just draw the sub-style and install the style on points A and B. It casts a visible shadow and make hour easy to read. But the material should not be too thick, or its thickness should be taken into account on the drawing.

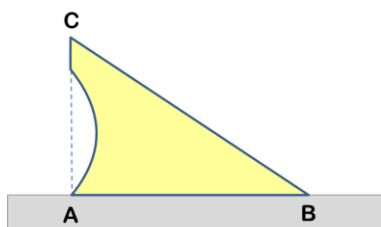

The triangle may be decorated as sometimes seen on old sundials, but always keep the correct position of points A, B and C. Point C casts a shadow on a declination line.

The line segment B-C casts a shadow along hour lines.

## The polar style

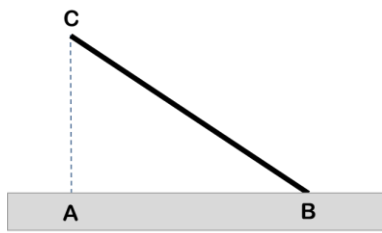

The polar style is a rod attached on point B and oriented parallel to the Earth axis. (*i.e.*, along the longest side of the triangle) and pointing at the north celestial pole.

The shadow of a polar style is parallel to hour lines.

It is sometimes necessary to support the style with a foot (additional rod that strengthens the style).

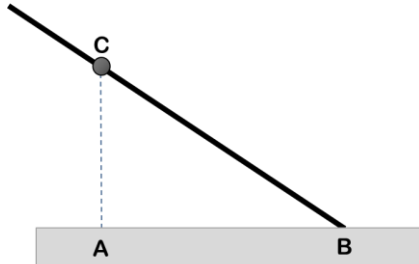

The polar style may be longer than the normal B-C length. In this case, it will be used to read hours but not dates or seasons (with declination arcs), unless a marker is added on point C.

Long styles sometimes have a ball fixed on point C in order to cast a shadow on declination arcs.

## The perpendicular style

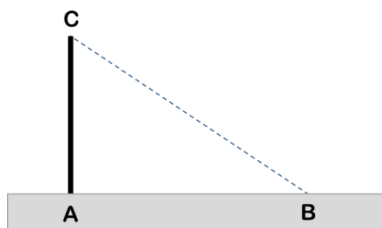

On some sundials, the style is a simple rod placed perpendicularly to the sundial plate at point A.

In this case, only the very end of the shadow is used for reading hours, which is not so convenient. It is used sometimes with ancient hours or sidereal hours.

## The polar eyepiece (pierced disk)

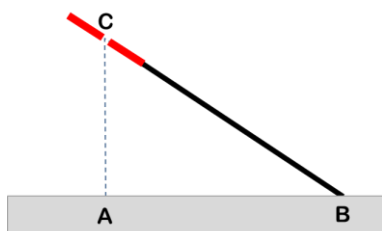

A polar style may support an eyepiece (pierced disk) at its end. Alternatively the disk may be supported by additional legs.

The hole at the center of the disk must be placed exactly at point C to function properly.

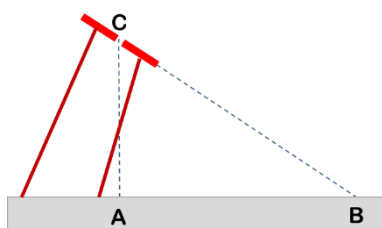

Supporting legs can be attached anywhere on the disk as they are not used for reading time. If the disk is attached to the polar style, care should be taken so that the polar style is securely attached to avoid bending in the wind.

## Truncated style

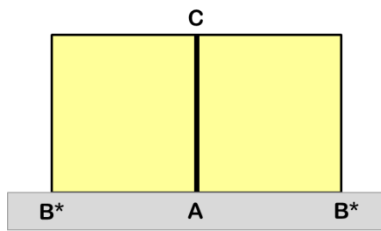

East- and west-facing sundials as well as polar sundials have their polar style parallel to their table. Point B, in this case, is rejected to infinity.

In such a case, a perpendicular style can be used, or a rectangle on one side or both sides. If the rectangle is on both sides, it will be necessary to mark point C.

## How to read time on a sundial?

Most sundials are giving local solar time.

Solar time is defined directly by the position of the Sun, with  $15^\circ$  of Hour Angle per hour of time. Earth is rotating around its axis in 24 hours, i.e.  $360^\circ/24 \text{ h} = 15^\circ/\text{hour}$ . It is noon in solar time when the Sun is passing at the local meridian (direction of the South in the northern hemisphere).

Solar time depends on the position of the observer, and it is different with longitude.

On a sundial, the solar noon line corresponds to the highest altitude of the Sun in the sky and to its passing at the local meridian. It is therefore always within the North-South plane and is always vertical on a vertical sundial, regardless of its declination.

To obtain watch time from solar time, you have to apply three corrections:

- The longitude correction
- The Equation of time
- The Daylight-Saving time (DST) when it applies

The following schematics explains the different paths to follow in order to convert solar time to civil time and vice versa.

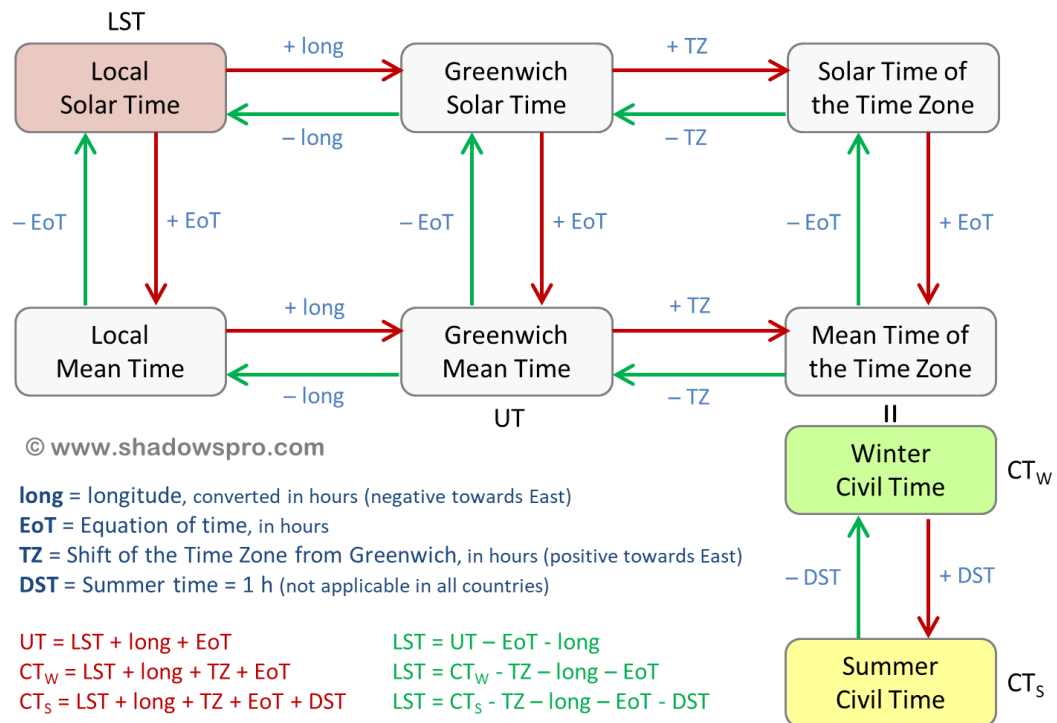

## Longitude correction

Europe is using the same Time Zone CET (Central European Time), except United Kingdom, Ireland and Portugal that are using WET (West European Time) and some Eastern countries that are using EET (Eastern European Time). Countries that use CET cover a wide span from the Western extend of Spain, with Vigo, to the Eastern border of Poland, which corresponds to a span of 2 hours of solar time. For locations at the East of the CET meridian, time is shifted towards morning (Sun is rising and setting earlier). For locations at the West of the meridian, it is the contrary, time is shifted towards the evening and Sun is rising and setting later.

One must calculate the longitude correction with regard to the reference meridian of the local time zone. Or to the Greenwich meridian and then compensate for the time shift between time zones. For example, for Besançon, France, located at 6° 02' East, the correction with regard to the CET meridian (UT+1h) is:  $15^\circ - (6^\circ 02') = 8^\circ 58'$  of longitude distance from the meridian, and  $(8+58/60)*4 \text{ min} = 35 \text{ min } 52 \text{ s}$  of time difference. When the Sun passes the local meridian in Besançon, it already passed the reference meridian almost 36 minutes ago (Central European Meridian). For a location East of the reference meridian, you will get a negative value. For example, in Warsaw (21° East), you will get -24 minutes i.e. for 12 hour of solar time, it will be 11 h 36 of solar time at the reference meridian.

The numerical application of the above graph for Besançon, on July 26<sup>th</sup>, 2014, we get:

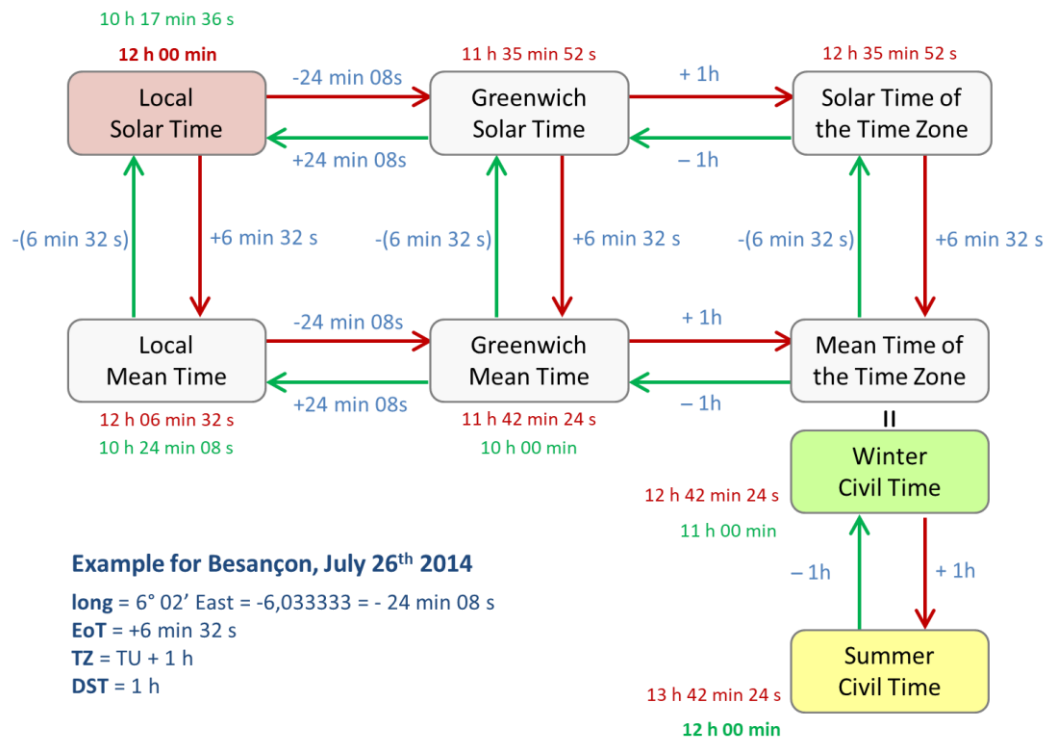

If we start from Solar Time (red arrows):

- Solar hour at noon: 12 h
- Longitude correction: 6° 02' East = - 24 min 8 s + 1h = + 35 min 52 s
- Equation of time: 6 min 32 s
- Summer time (DST): + 1 h

So, when it is 12h of solar time on the sundial in Besançon, on July 26<sup>th</sup>, 2014, it is in fact 13 h 42 min 24 s on the watch (civil time in central Europe).

On the contrary, if we start from the time given by the watch (green arrow):

- Watch time (civil time): 12 h
- Summer time (DST): - 1 h
- Equation of time: - 6 min 32 s
- Longitude correction: - 1 h + 24 min 8 s = - 35 min 52 s

It gives 10 h 17 min 36 s of solar time for noon on the watch.

This method can also be used to anticipate the civil time of the passing at the local meridian (solar noon), for a given location. Or calculate the solar time for any civil time.

## The horizontal sundial

This is the horizontal sundial with polar style. Other types of horizontal sundials exist such as the horizontal analemmatic sundial described later in this document.

### Geometry of the sundial

The table of a horizontal sundial is parallel to the horizontal plane of the location (which is not always parallel to the ground!), that is perpendicular to the vertical line defined by a plumb-line.

The style, planted in the table is directed according to the north-south axis and points towards the celestial pole. The angle formed between the style and the table is equal to the latitude of the location. The opposing angle, at the end of the polar style is equal to the co-latitude ( $90^\circ - \text{latitude}$ ) of the location. Thus, for a horizontal sundial located at the North Pole, the style will be vertical, whereas at the equator, the angle will be null and the style will be horizontal.

### Limits of illumination

A horizontal sundial gives the hours of the morning and of the afternoon. In the countries of high latitude, it may be illuminated all 24 hours of the day, during the summer.

In the northern hemisphere, the sun reaches its highest declination on the summer solstice (21<sup>st</sup> of June) and the resulting shadow is at its shortest. During the winter, it is the opposite, with the lowest declination reached at the winter solstice (December 21<sup>st</sup>) where the shadow reaches longest.

During the equinoxes, the extremity of the style projects a shadow on a line oriented exactly east-west.

For a location in the tropics, the declination of the sun may be greater than the latitude. In this case, the sun passes over the zenith and generates an inverted shadow. For such a location, the declination lines are drawn on each sides of the style. At noon, for a declination equal to the latitude, the sun does not generate any shadows!

Horizontal sundials can be found on small columns in garden and squares. The table is often polygonal or circular.

### Construction

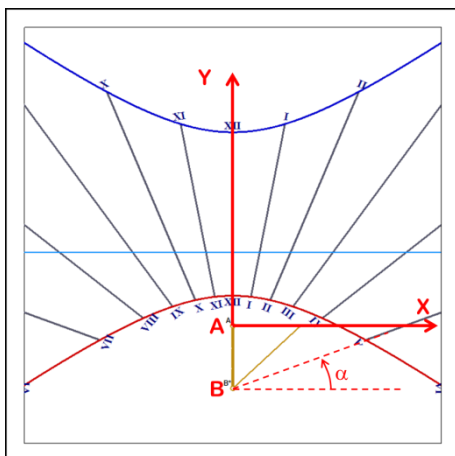

The generated table of coordinates provides information for graphical construction of the various lines that make up the horizontal sundial. Coordinates for the hour lines, declination lines and analemma are tabulated using both Cartesian (x and y in millimeters) and polar format (radius in millimeters and angle in degrees).

Cartesian coordinates are given in millimeters from the origin at point A with the X axis towards the right and the Y axis towards the top.

Polar coordinates are given with respect to the fixed point B (pole) with the radial coordinate given in millimeters and the angular coordinate given in degrees with a convention of positive angles defined counterclockwise from the horizontal

### Installation

Horizontal sundials are usually found on small columns in parks and gardens. The table is sometimes circular or polygonal.

The sundial must be oriented along the meridian line (M), its style pointing to the pole (P):

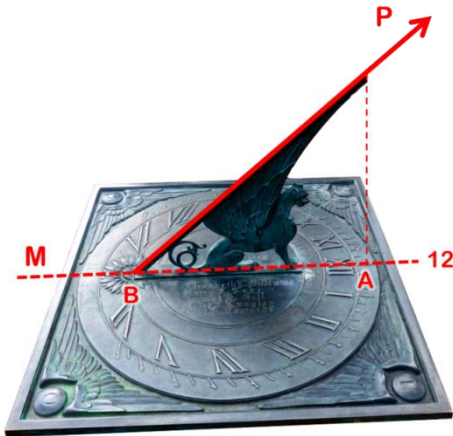

*Horizontal sundial at the Lowell observatory in Flagstaff (AZ, USA) – Photo FB.*

# The vertical direct south sundial

## Geometry of the sundial

This sundial is installed on a vertical wall. In the northern hemisphere, it faces south and in the southern hemisphere it faces north.

The style points towards the ground and forms an angle with the plate equal to the co-latitude ( $90^\circ - \text{latitude}$ ).

The solar noon line is vertical and superimposed on the sub-style line.

## Limits of illumination

The sundial is lit as soon as the sun is above horizon and more south (more north in southern hemisphere) than the east-west line. If it is installed in the tropics, there will be a period of the year where it is not lit as the sun is behind the wall. It may be possible to install a complementary sundial on the other side of the wall.

At the summer solstice, when the sun is at its highest point in the sky, the shadows are long and extend far from the base of the style. On the contrary, during the winter, the shadows remain close to the base of the style.

## Construction

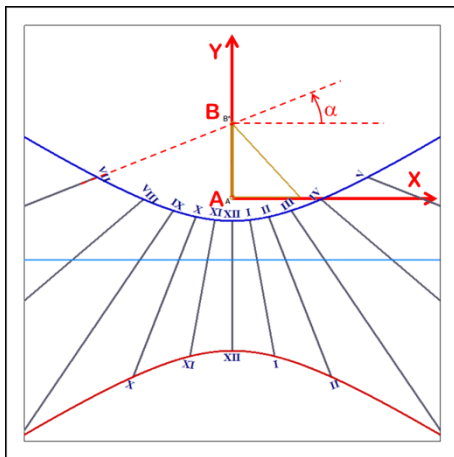

The generated table of coordinates provides information for graphical construction of the various lines that make up the vertical direct south sundial. Coordinates for the hour lines, declination lines and analemma are tabulated using both Cartesian and polar format. Cartesian coordinates are given in millimeters from the origin at point A. Polar coordinates are referenced to the fixed point B (pole) with the radial coordinate given in millimeters and the angular coordinate given in degrees with a convention of positive angles defined counterclockwise from the horizontal.

## Installation

A vertical direct south can be combined with a horizontal sundial with a single style to create a double sundial.

This type of sundial is often associated with a meridian sundial with an analemma curve that provides the equation of time and longitude correction to allow reading of mean time.

The vertical direct south sundial is the most common type of sundials. It is usually seen on the bell tower of a church, on the facade of a public building, or on private homes.

The sundial must be installed exactly facing south (north in southern hemisphere) and the style perfectly aligned with the Earth's rotation axis:

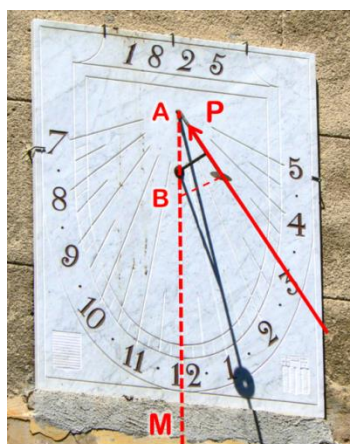

*Vertical direct south sundial, Aix-en-Provence, France – Photo FB.*

## The vertical declining sundial

### Geometry of the sundial

The vertical declining sundial can be installed on any vertical surface not aligned with one of the cardinal directions. That is all the orientations between those of a vertical direct east and a vertical direct west dial, as well as orientations between the vertical direct south and the vertical direct north dial.

Here a critical measurement is the declination of the plate when attached to the wall. One measures the azimuth of the wall compared to due south in the northern hemisphere or to due north in the southern hemisphere. An azimuth of  $0^\circ$  will give a vertical direct south (north in southern hemisphere) dial. An azimuth of  $90^\circ$  east will give a vertical direct east sundial. Lastly, an azimuth of  $180^\circ$  will give a vertical direct north (south in southern hemisphere) dial.

The vertical declining sundial provides very interesting lines for an azimuth between  $20^\circ$  and  $60^\circ$ .

### Limits of illumination

The plate of the vertical declining sundial is illuminated when the Sun is above the horizon and passes in the semi-circle centered on the wall declination ( $d-90^\circ$  to  $d+90^\circ$ )

A sundial declining towards north (south in the southern hemisphere) will be illuminated shortly in the morning and again shortly in the evening, but not during the day. In winter, the sundial may not be illuminated at all.

## Construction

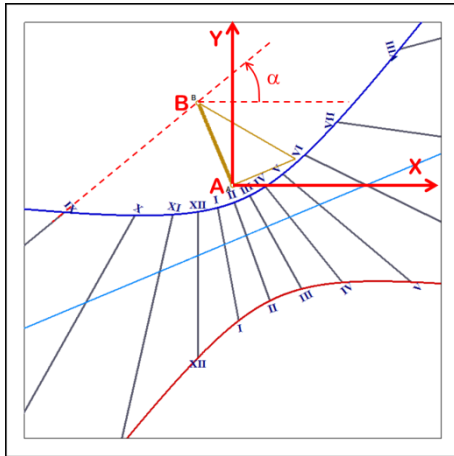

The generated table of coordinates provides information for graphical construction of the various lines that make up the vertical declining sundial. Coordinates for the hour lines, declination lines and analemma are tabulated using both Cartesian and polar format. Cartesian coordinates are given in millimeters from the origin at point A. Polar coordinates are referenced to the fixed point B (pole) with the radial coordinate given in millimeters and the angular coordinate given in degrees with a convention of positive angles defined counterclockwise from the horizontal.

For dials with a large declination angle, point B is projected far from point A, and the polar coordinates are not given.

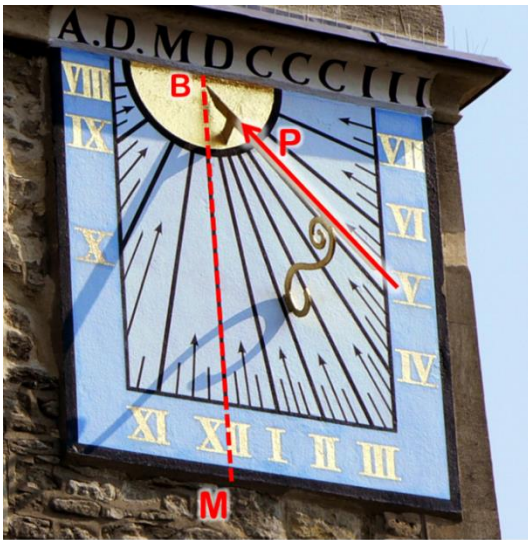

In the northern hemisphere, when the style is on the right side of the noon line, it is declining towards west, and is illuminated mainly in the afternoon. If the style is on the left side, it is a morning sundial as it declines towards east. In the southern hemisphere, the situation is reversed.

*Left, declining sundial on the St Cross church in Oxford, United Kingdom. Photo FB.*

# The vertical direct west sundial

## Geometry of the sundial

The vertical direct west sundial faces precisely west. Its style is rectangular with the upper edge oriented towards the celestial pole. Point B is cast to infinity and hour lines are parallel to each other and to the sub-style.

## Limits of illumination

The vertical direct west sundial can only give hours from local noon to the sunset. Around noon, the shadow is oblique and its end is projected to infinity. Furthermore, the accuracy of readings just after noon is not very good due to construction and installation tolerances.

## Construction

The style is usually built as a large rectangle with a notch to locate the shadow on the declination lines. Sometimes the style is just a perpendicular rod fixed at point A. Points B\* are arbitrary and defined by the length of the truncated style (see [Dimensions](#) dialog box).

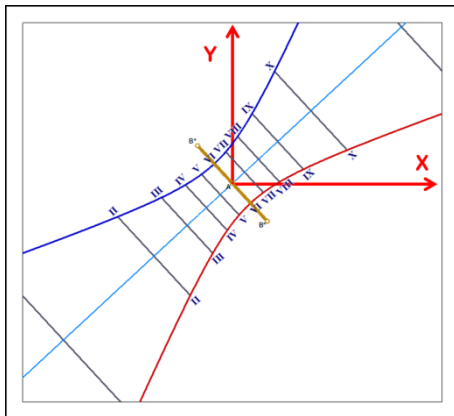

The generated table of coordinates provides information for graphical construction of the various lines that make up the vertical direct west sundial. Coordinates for the hour lines, declination lines and analemma are tabulated using both Cartesian and polar format. Cartesian coordinates are given in millimeters from the origin at point A. Polar coordinates are referenced to the fixed point B (pole) with the radial coordinate given in millimeters and the angular coordinate given in degrees with a convention of positive angles defined counterclockwise from the horizontal.

## Installation



The sundial must be installed on a vertical wall facing the West. The most important part of the style is its end that can be realized as an eye piece (disk with a hole) or by a simple rod with or without a portion of the polar style at its end.

*Left, direct west sundial painted on Albi cathedral, France – Photo FB.*

# The vertical direct east sundial

## Geometry of the sundial

The direct east sundial faces precisely east. Its polar style is parallel to the sundial plate and to the Earth's rotation axis. Point B is rejected to infinity and hour lines are parallel to each other. This is why, the style of this sundial is usually a rod planted on point A. The whole sundial plate is included in the meridian plane.

## Limits of illumination

The vertical direct east sundial can only give hours from sunrise to the local noon. Around noon, the shadow is oblique and its end is projected to infinity. Consequently, the accuracy is not very good due to construction and installation tolerances.

## Construction

The style is usually built as a large rectangle with a notch to locate the shadow on the declination lines. Sometimes the style is just a perpendicular rod fixed at point A. Points B\* are arbitrary and defined by the length of the truncated style (see [Dimensions](#) dialog box).

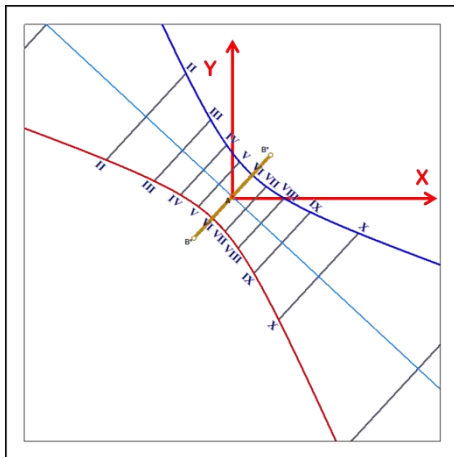

The generated table of coordinates provides information for graphical construction of the various lines that make up the vertical direct east sundial. Coordinates for the hour lines, declination lines and analemma are tabulated using both Cartesian and polar format. Cartesian coordinates are given in millimeters from the origin at point A. Polar coordinates are referenced to the fixed point B (pole) with the radial coordinate given in millimeters and the angular coordinate given in degrees with a convention of positive angles defined counterclockwise from the horizontal.

## Installation

The dial is installed on a vertical wall facing east. The style can be a simple rod planted perpendicular to the dial plate at the point A. But a bar can also be installed parallel to the dial plate, oriented towards the Celestial Pole.



*Direct east sundial in the Invalides, Paris – Photo FB.*

## The meridian dial

A meridian dial is a variant of a classical sundial, often horizontal or vertical. Large horizontal meridian dials can be found on some churches while vertical meridian dials are more common and usually have an analemma curve around the noon line.

A meridian dial aims at providing mean time around noon; this is why it provides time usually 30 minutes to a maximum of one hour before or after noon.

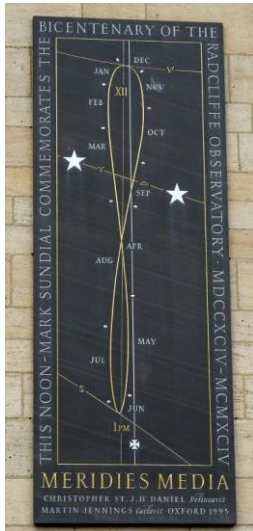

Oxford

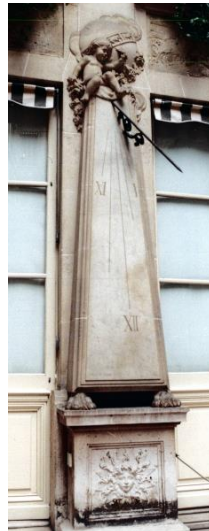

Paris –Crillon hotel



Dijon – Palace of the Dukes



Montbéliard  
Pré la rose park

Several large horizontal median dials can be found adorning Italian or French churches (e.g., the famous Saint-Sulpice church in Paris with the “rose line”).

Shadows makes it possible to create a meridian dial from any sundial with polar style. To do so, check the option [Make it a meridian sundial](#) in the selection of type of sundial with polar style during the creation process. It is also possible to choose  [Limit hours of the sundial](#) in the [Drawings](#) menu.

The meridian sundial option will limit hours to between 11 h and 13 h. All of the other options can be used. Recommended options on meridian sundials are to draw hour lines with a span small enough to provide accuracy, for example every 5 minutes, and to draw the analemma curve around noon with Zodiacal symbols, or dates to help users to read the difference on the correct side of the curve.

### Graph of visibility hours of the meridian sundial

This graph provides the time, expressed in civil time, of the Sun’s passing of the meridian for a given date. It allows one to know at what civil time the shadow of the style will be visible on the meridian sundial, and especially on the analemma curve. The longitude correction is already included in the curve. The value of the equation of time can be deduced by the difference between the curve and the 12 h line.

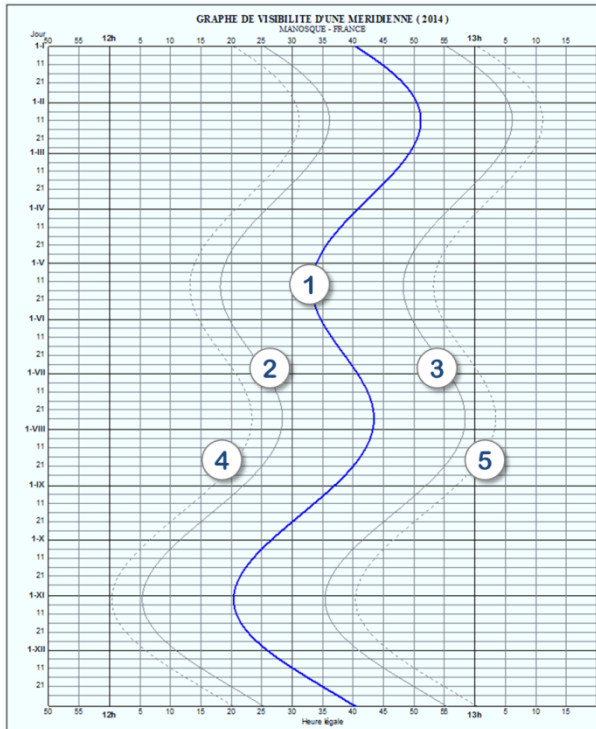

1. Solar noon – hour of Sun’s passing the local meridian.
2. Curve of 11h45 in solar time
3. Curve of 12h15 in solar time
4. Curve of 11h40 in solar time (*i.e.*, approx. when the shadow enters the meridian dial)
5. Curve of 12h20 in solar time (*i.e.*, approx. when the shadow leaves the meridian dial)

## The equatorial sundial

The equatorial sundial is a special case of the inclining dial, for which the layout of the hour lines becomes very simple. Indeed, the face of this dial is in the plane of the celestial equator (extension of the terrestrial equator to infinity).

The style is perpendicular to the plate, and directed towards the celestial pole. The shadows are rectilinear and move oppositely to the sun at the same speed. Hour lines are thus regularly spaced every  $15^\circ$  ( $360^\circ/24$  h). Declination lines are always circles.

This type of sundial is seasonal because when the sun is above the celestial equator, it illuminates the upper side of the dial, whereas during the rest of the year, it illuminates the lower side. Around the equinoxes, this dial is lit edge-on all day long, and it is quite impossible to read the hour on it.

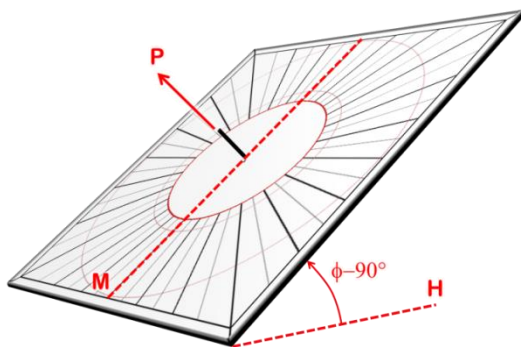

Upper side. The style points towards pole.

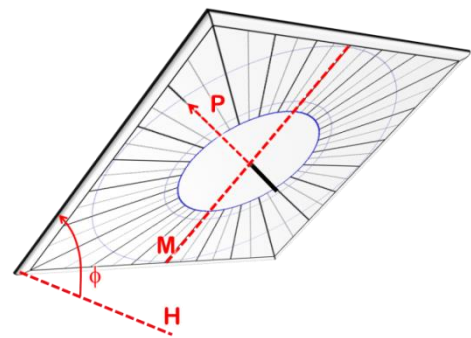

Lower side



Left: one of the three equatorial sundials made in white marble, visible at the Forbidden City, Beijing, China.

A single style emerges on both sides to allow reading time all year long.

Photo FB.

## The polar sundial

### Geometry of the sundial

The polar sundial plate is parallel to the pole axis and is facing the intersection point between the celestial equator and the local meridian. The inclination of the sundial plate is equal to the latitude. Therefore it is the complementary sundial of the equatorial sundial.

The hour lines of the polar sundial are all parallel and oriented towards the pole.

The style can be a simple rod placed at point A perpendicularly to the sundial plate, or it can be a rectangular style place between the two points B\*. It is the same kind of style as for a vertical direct east or west sundial.

### Limits of illumination

The polar sundial (non-declining) is illuminated throughout the year and as long as the sun is over the horizon, just as for a horizontal sundial.

### Construction

The y axis is oriented along the polar axis, towards the pole.

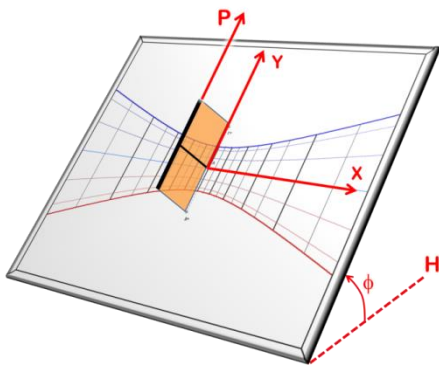

*Polar sundial with analemma curve in order to provide civil time. Created by Dan O'Neal for the city of Santa Avelina in Guatemala.*

### The declining polar sundial

This variant of a polar sundial has its plate rotated around the polar axis by a given angle. If this angle is  $90^\circ$  towards west, it gives a normal direct west sundial.

The declining polar sundial can be used to create a multiple sundial on the sides of a polyhedron cylinder oriented along the polar axis. For example, a cylinder with 8 sides can sport a direct south polar sundial, two polar sundials declining by  $45^\circ$  east and west, two polar sundials declining by  $90^\circ$  east and west and two polar sundials declining by  $135^\circ$  east and west. The latest declines by  $180^\circ$  and is never lit by the sun.

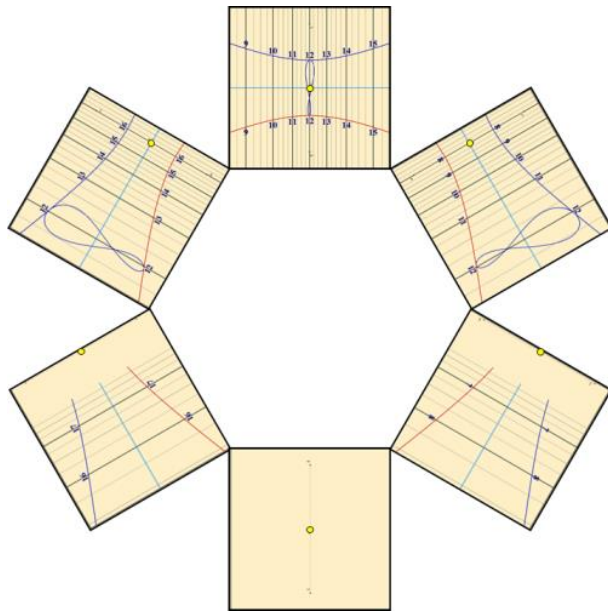

*Example of a multiple polar sundial on a hexagonal cylinder. Imagine that each sundial is folded on the sides of a cylinder. Declinations are  $60^\circ$ ,  $120^\circ$  and  $180^\circ$  around the polar axis.*

## The declining and inclining sundial

This sundial is installed on a plane that is neither vertical nor horizontal (inclining) and that do not face the local meridian (declining). Declining and inclining sundials are quite rare because such supports are not common in architecture. They can be installed, for example, on chamfers on a church, or on rocks. Some angles may be interesting as they generate nice layouts with hour lines and declination lines.

Such sundials are sometimes found on multiple sundials. For example, a polyhedral sundial (*e.g.*, with 10 sides) may have such inclined and declining sundial on sides that are neither horizontal nor vertical.

Note: equatorial and polar sundials are examples of inclined sundials.

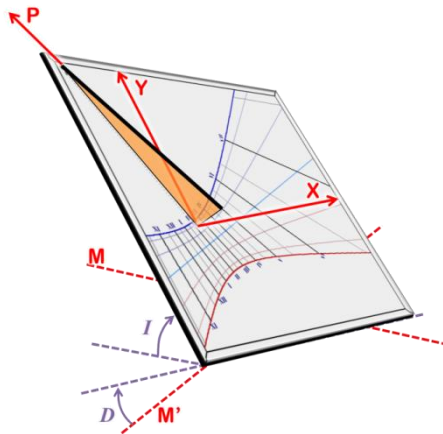

This sundial is characterized by both **inclination  $I$**  measured from the horizontal plane and by its **declination  $D$**  measured from the east-west line  $M'$ .

## Changing the declination and the inclination

Go to the [Configuration](#) menu >  [Change the sundial's orientation / inclination...](#) The modification is applied in real time so that you can see how changes affect the layout.

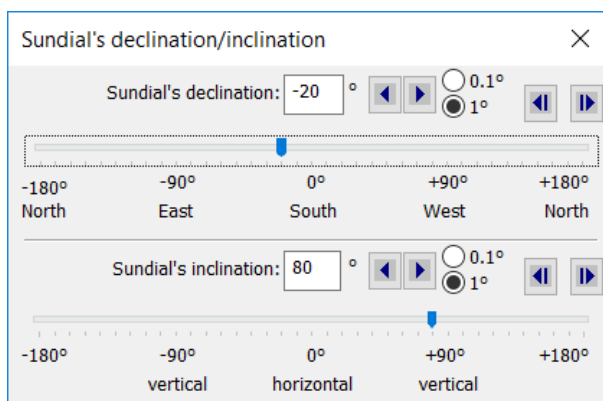

A vertical declining sundial can be changed to another declination, but not in inclination/reinclination.

A general plan sundial can be oriented and inclined in both directions.

## The spider sundial

The spider sundial is built on the same basis as a sundial with polar style. It can be inclined and declining. Its name comes from the layout that looks like a spider web due to oscillating hour lines and circular declination lines.

Hour lines are in fact drawn with the equation of time inclined. They are unfolded to allow a linear reading depending on the date from the inner circle to the outer circle. The style must be a polar style, long enough to allow the reading on all circles.

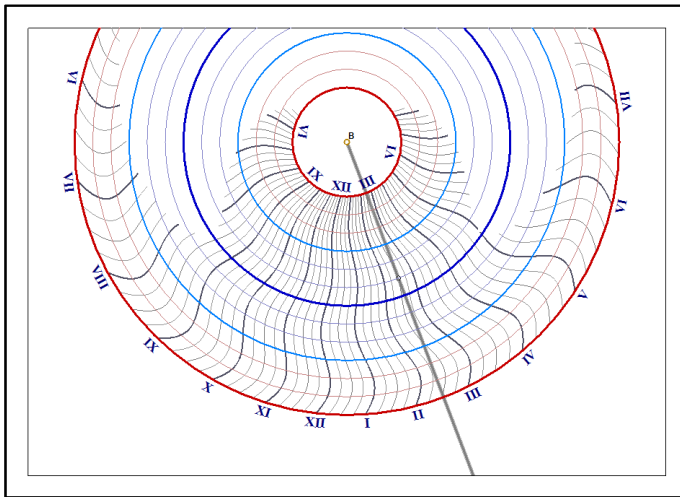

The hour is read at the intersection between the circle corresponding to the date and the shadow of the style. The exact value is interpolated between the two closest hour lines.

By default, the inner circle corresponds to the summer solstice. The blue circle in the middle is the winter solstice and the outer circle is again the summer solstice.

The length of the shadow is not important here. It is only the intersection of the shadow with the circle corresponding to the current date that matters. The hour is read on this intersection between the closest undulating lines.

This type of sundial does not allow one to display other types of hour lines (such as Italic hour lines)

When the shadow of the style is visualized on the sundial, a circular marker is drawn to help read the time. This sundial makes it possible to directly read civil time, as on your watch.

Options for the circles are the same as for declination arcs on a classical sundial (by date, Zodiac or declination).

Spider sundials are available in [Shadows Expert](#) or [Shadows Pro](#).

## Analemmatic sundials

Analemmatic sundials are a family of sundials that have a mobile style moving with the date. An analemmatic sundial is made of a large ellipse labeled with hour points and a date line in the middle of the sundial where the style is placed.

The most common analemmatic sundial is horizontal. It is usually drawn on the ground as a large ellipse with the role of the style played by someone standing at the appropriate position on the date line. By holding a hand overhead, a shadow is cast that intersects the ellipse at a point where hour is read.

### History

The first analemmatic sundial installed in France and probably the World's first analemmatic sundial is at the Brou church. It is dated from 1513 and was first described in 1644 by [Vauzelard](#) who is now considered as the theoretician of analemmatic sundials. A very few analemmatic sundials have been created before 1950: Dijon (1827), Besançon (1902), Montpellier (1927), Avignon (1931).

### Position of the style

In an analemmatic sundial, the style is a straight rod perpendicular to the sundial plate, positioned at the correct date on the central date line. The date line is labeled with date or declination or zodiacal symbols. On a small analemmatic sundial, the date line is usually a groove allowing the style to slide or a series of holes to accept the style at the correct date.

### Reading time

If the shadow is long enough and intersects the ellipse, solar time is directly read at the intersection. In case the shadow is too short, it must be extended to the ellipse (see below).

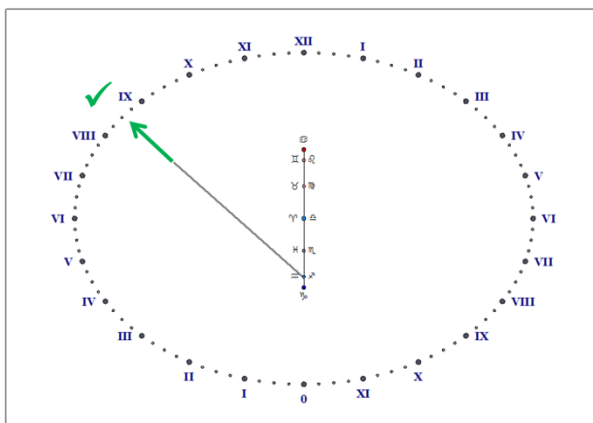

*Correct reading of time:  
by extending the shadow to the ellipse*

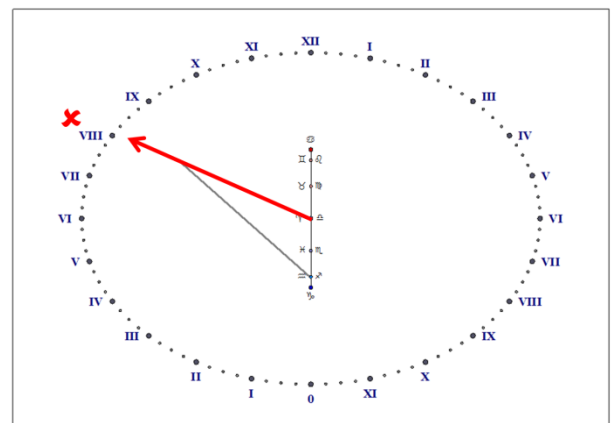

*Incorrect reading: by drawing a line  
from the center to the shadow end*

Contrary to what can be seen on the Brou sundial, it is not possible to draw an analemma curve on the date line and place the style on this curve to get the mean time. This is therefore why *Shadows* does not allow the display of mean time on an analemmatic sundial.

### The ellipse

As latitude increases, the ellipse tends to be more circular and the date line tends to be shorter. At the pole, an analemmatic would be circular with a date line as a single point, and would be identical to an equatorial sundial. On the equator, the analemmatic sundial is reduced to a single line scaled with hour points, and the date line is maximum.

Analemmatic sundials are available only in [Shadows Expert](#) and [Shadows Pro](#).

## The horizontal analemmatic sundial

The minor axis of the ellipse is aligned on the meridian line (north-south) and its major axis is aligned on the east-west line.



*Analemmatic sundial of the promenade du Peyroux in Montpellier. Photo FB.*

*The user stands on the date line, at the position corresponding to the date and he raises his arm vertically above him. Time is read by extending the shadow to the ellipse.*

Depending on the location, the eccentricity and the length of the date line are changing. Such horizontal analemmatic sundial installed at the pole would be equivalent to a classical equatorial sundial; the date line would be a single point and the ellipse would be a perfect circle. On the contrary, installed on the equator, the date line would be the longest and the ellipse would be a simple line, oriented East-West.

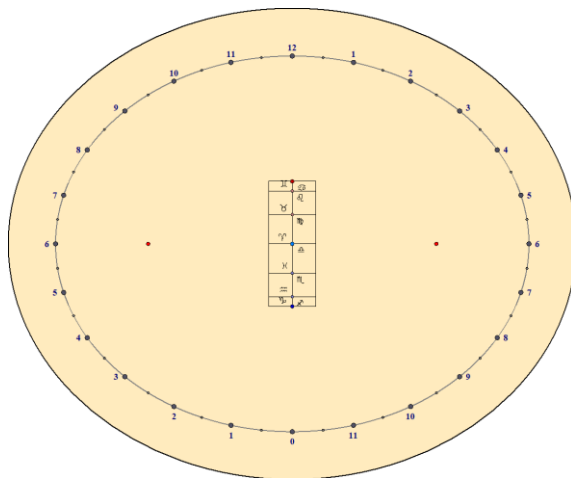

Horizontal analemmatic sundial  
for Berlin, Germany (52° 30' N)

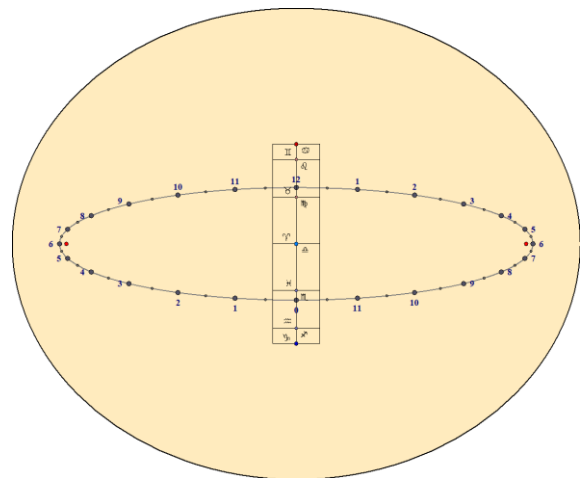

Horizontal analemmatic sundial  
for Bangkok, Thailand (13° 45' N)

## The vertical analemmatic sundial

Two different types of vertical analemmatic sundials are offered: the [vertical direct south](#) and the [vertical declining](#).

On a declining sundial, the date line is inclined and the ellipse is stretching with the declination. With a declination of 90° (direct east or west), the ellipse is just a line perpendicular to the date line and the date line makes an angle with the horizontal plane equal to the local latitude.

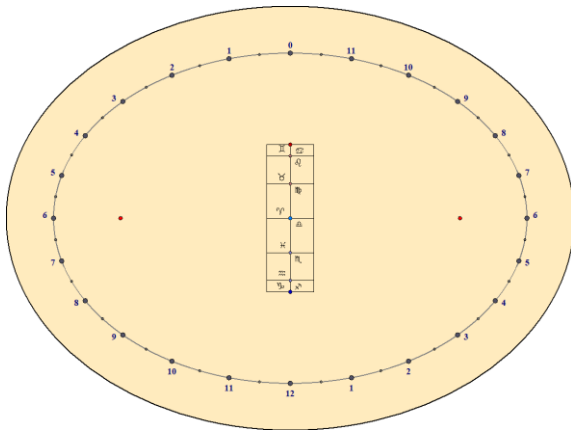

Vertical direct south analemmatic sundial

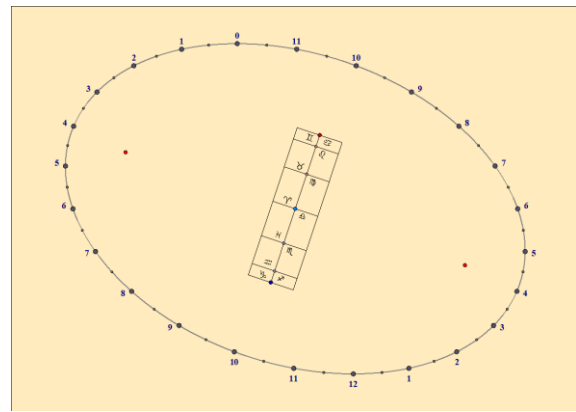

Vertical declining analemmatic sundial (20° east)

Vertical direct south analemmatic sundials are available in [Shadows Expert](#) and [Shadows Pro](#).

Vertical declining analemmatic sundials are available in [Shadows Pro](#).

## Options for the date line

The date line can be configured with several scales. Zodiac signs, date of the month or declination of the Sun, as on declination lines in a classical sundial.

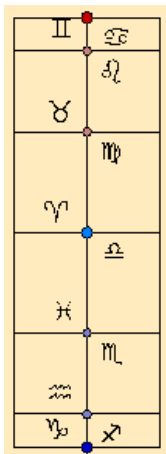

Zodiac signs

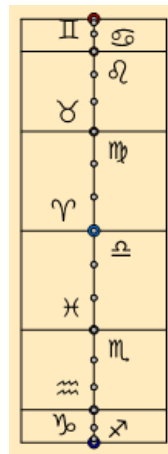

Zodiac signs and decants

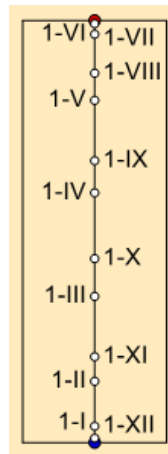

First day of each month

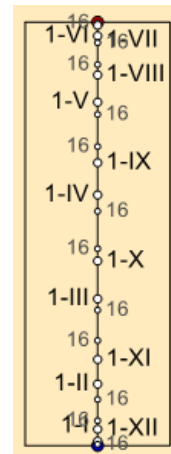

First and 16<sup>th</sup> day of each month

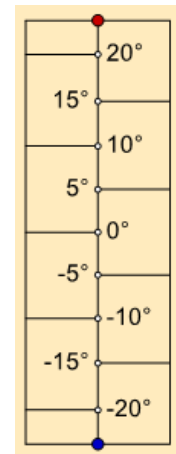

Declination of the Sun

## The armillary ring

This sundial is drawn in the inner surface of a semi-cylinder whose axis is inclined along the Earth's rotation axis. This sundial is a polar cylindrical sundial. Its style is its axis (usually a metal rod). Often a marker is installed at the middle of the axis in order to see the shadow moving with the Sun's declination. The marker can be a small sphere.

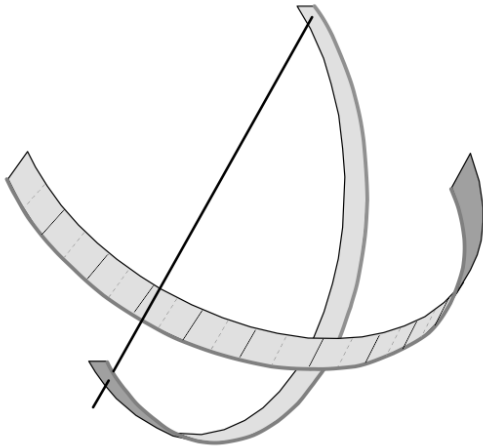

Hour lines are all parallel to each other and equally spaced. They mark the Sun's hour angle.

Declination lines are parallel circles crossing hour lines perpendicularly.

When the radius of the cylinder is large and the cylinder height is small, it leads to an armillary ring, the equatorial band of an armillary sphere.

This sundial gives the same indications as a planar polar sundial.

The armillary ring sundial is available in [Shadows Expert](#) and [Shadows Pro](#).



*Left: an armillary ring (polar cylindrical sundial) in Geneva (Switzerland).*

*Hour scales are marked with Roman numerals at 6h and 12h.*

*Parallel lines mark the Sun's declination every 5°.*

*An eyepiece casts a spot of light on the cylindrical surface to read time.*

*Below: the equivalent drawing in Shadows. The width of the band is calculated from the cylinder radius. It can be stuck on the internal surface of the cylinder, centered under the eyepiece.*

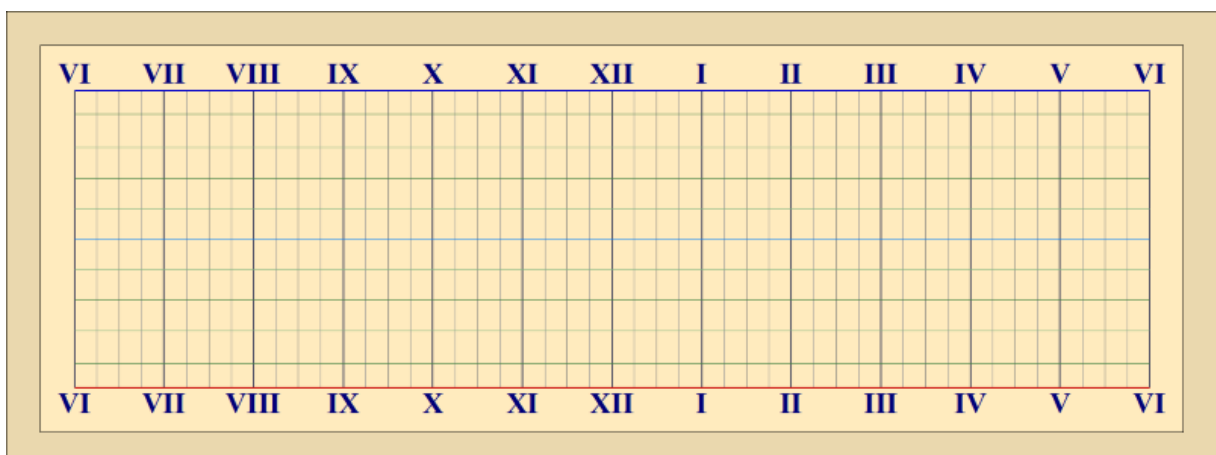

## The cylindrical polar sundial without style

It is a cylinder cut through its middle and oriented along the Earth rotation axis.

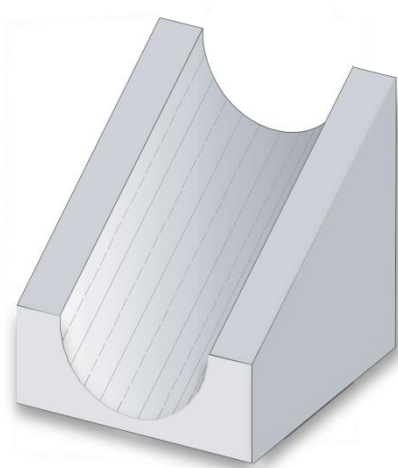

This sundial does not have any style. The shadow is cast by one of its lateral edges. In the morning, time is read by the shadow cast by the right edge of the cylinder (left in the southern hemisphere). In the afternoon, the shadow is cast by the other edge.

Hour lines are swept by the shadow twice during the day, once by each edge.

This sundial is available in [Shadows Expert](#) and [Shadows Pro](#).

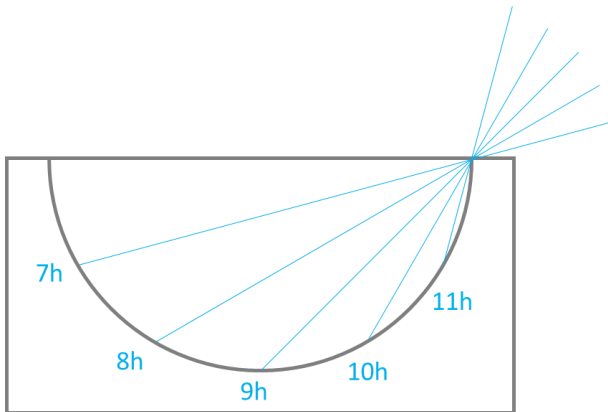

*Example for the northern hemisphere, drawn in the polar plane:*

*At Sun rise, the shadow of the right edge is casted on the left edge, then the limit between light and shadow falls into the cylinder as the Sun rises in the sky.*

*At noon, the Sun is directly above the cylinder and no shadow is casted. The cylinder is fully lit.*

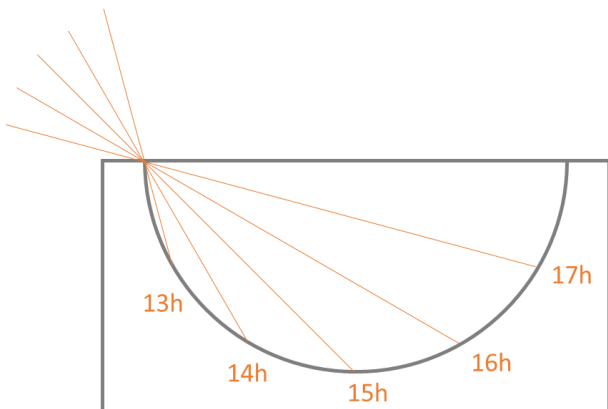

*In the afternoon, the Sun starts to go down to West and the shadow is produced by the left edge.*

*The shadow goes down into the cylinder then rises on the right side towards 18h solar hour, where the cylinder is fully in the shadow.*

In the southern hemisphere, the process would be reversed with the Sun moving from left to right.

## The shepherd's dial

This sundial is drawn on the external surface of a cylinder held vertically. The style is perpendicular to and can be rotated around the cylinder axis. When using this dial, rotate the style to align it with the date then rotate the whole cylinder to have a vertical shadow (the style is then facing the Sun direction). The length of the shadow gives the time. It is important that the bottom edge of the style is exactly at the top of the network of lines.

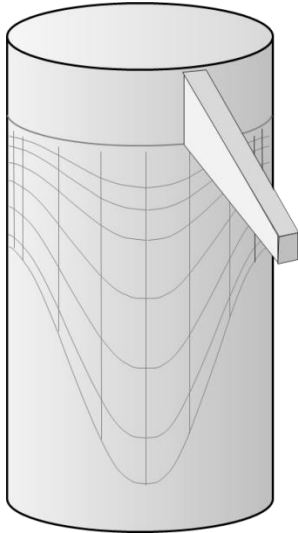

The shepherd's dial uses the Sun's altitude instead of its hour angle to indicate the time, in contrast to other types of sundials.

The shepherd's dial is usually made from a wooden cylinder that can easily be stored in a pocket. It has a ring on the top with a small rope to hang it vertically.

It can be used throughout the year but it requires the date to be known in order to rotate the style correctly. It can only give the solar time.

Vertical lines are drawn by default for zodiac signs changes. They are equivalent to declination lines and can be configured

in the [Drawings](#) menu >  [Properties of declination lines...](#) It is possible to scale the lines by date.

This sundial is available in [Shadows Expert](#) and [Shadows Pro](#).

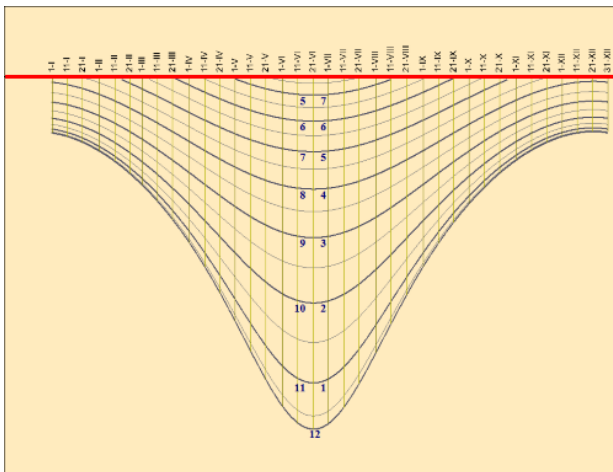

*Drawing in Shadows.*

*The red lines correspond to the bottom edge of the style.*



*Shepherd sundial made with ivory  
Museum of Sciences, Oxford, UK*

## The vertical cylindrical sundial

This sundial is drawn on the external surface of a vertical cylinder and has a style planted perpendicularly to the surface. The perpendicular style can be declining, that is it can face any azimuth. However, the polar style needs to intersect the cylinder surface at point B. The more declining the dial, the more shifted is the layout.

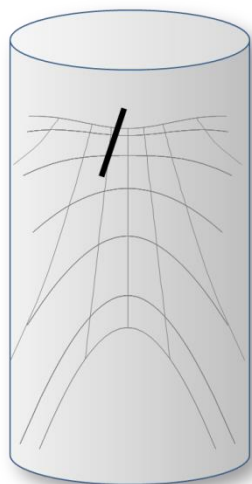

*Direct south (not declining)*

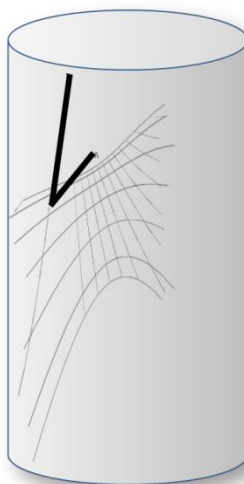

*Declining by 30° towards west*

This sundial can be installed on a round tower of an old house or on a castle.

This sundial is available only in [Shadows Pro](#).

## Bifilar sundials

Bifilar sundials constitute a family of dials where the "style" is made of two orthogonal threads tight above the sundial at two different heights. The shadow cast by the threads is a cross. This type of sundial was discovered by German mathematician [Hugo Michnik](#) in 1922. Since then, a number of variants have been explored, like the declining vertical bifilar sundial.

One of the threads is called the [meridian thread](#) because it is contained by the local meridian plane. The other thread is called the [transversal thread](#) and is always perpendicular to the meridian thread.

The furniture of a bifilar sundial is similar to the one of a classical sundial: hour lines converge to a single point and diurnal arcs are hyperbolas. One can consider that the point where hour lines converge is equivalent to the attachment point of the polar style in a classical sundial (point B). Similarly, the point located right below the thread intersection is equivalent to the attachment point of the perpendicular style in a classical sundial (point A).

When the height of each thread is properly calculated, hour lines are spaced regularly (every  $15^\circ$ , as in an equatorial sundial) resulting in an equiangular bifilar sundial. In this case, the height of the transversal thread is calculated from the height of the meridian thread and the latitude.

In case the two threads are at the same height, we obtain the same layout as with classical sundial with a polar style. The crossing point of the two threads coincide with the end of the perpendicular style. This alternate type of style may be a good solution to replace the polar style that may cause injuries when the sundial can be reach by the public.

Bifilar sundials are available only in [Shadows Pro](#).

### The horizontal bifilar sundial

This horizontal sundial has one thread oriented north-south (meridian thread) and another thread, oriented east-west (transversal thread).

The center of the dial (where hour lines converge) is slightly shifted towards south, compared to the point located beneath the crossing of threads. The noon line is oriented north-south as in a classical horizontal sundial.

If the sundial is equiangular, the transversal thread lays under the meridian thread and the hour lines are equally spaced every  $15^\circ$ .

The horizontal bifilar sundial is an excellent alternative to the horizontal sundial when a style with a sharp point might create a hazard for the public, while it offers a similar drawing.

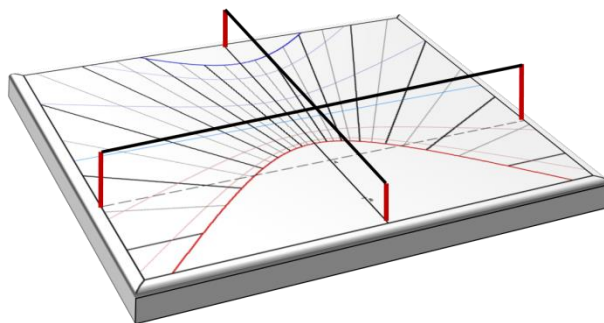

### The vertical declining bifilar sundial

The general vertical bifilar sundial has a vertical thread, parallel to the wall (meridian thread) and a horizontal thread (transversal thread), oriented east-west when the sundial is not declining.

The interesting property of an equiangular vertical bifilar sundial is that threads are no longer horizontal and vertical, but inclined (yet they remain orthogonal to each other). The meridian thread is above the sub-style line. Another bizarre property is that the noon line is not vertical. Hour lines are regularly spaced every 15°.

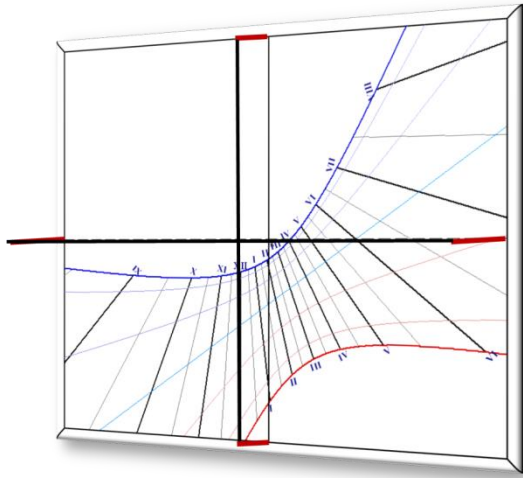

*Vertical declining bifilar sundial,  
with horizontal and vertical threads*

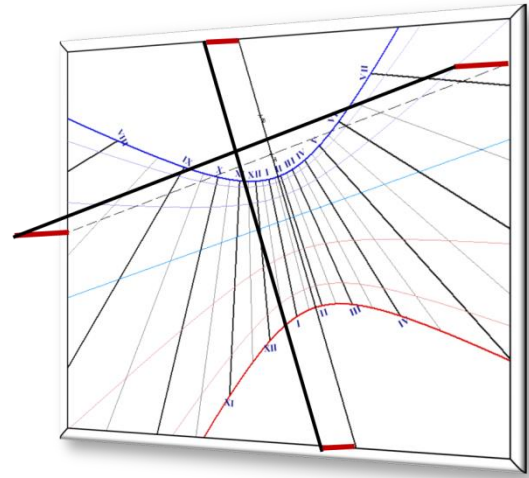

*Vertical declining bifilar sundial,  
with equally spaced hour lines. Threads are inclined.*

*This page is left intentionally blank*

## PART 3 – ASTROLABES

### Introduction to astrolabes

*Note: please refer to the glossary to find the definitions of technical terms used in this text.*

An **astrolabe** is a representation of the celestial sphere on a plane. It is an astronomical calculator used for example to find hours of setting or rising of the Sun or of a star, or to convert coordinates of a star from a coordinate system to another (horizontal, equatorial, ecliptic), or to find azimuth, altitude, right ascension, declination, etc.

The origins of the astrolabe are not very precise; We know the early contributors who wrote the first treatises on the astrolabe, between the 3rd and 6th century, and we know also that **Ptolemy** wrote an essay on the stereographic projection in his book *planisphaerium*, three centuries before Christ. Literature around astrolabes really flourishes between the 9th and 12th century, especially with the numerous translations of ancient Greek and Arabic treatises, and also with the conquest of the south of Europe by Arabs, leading to the famous Spanish-Arabic school whom **Arzachel** (Al Zaqali) is the most famous member.



*A French astrolabe from the 17th century at the Smithsonian Air and Space museum in Washington.*

The astrolabe spreads between the 12th and 16th century, on the one hand towards Orient and Persia, and on the other hand across the rest of Europe, especially Paris, Germany and Netherlands where artisans and goldsmiths, who were not always scientific or astronomers, made beautifully decorated astrolabes. They used to replicate existing astrolabes and sometimes they introduced errors. One of the most famous astrolabe makers is **Arsenius** from Belgium. The 17th century marks the beginning of astrolabe clocks, such as the famous clock in Prague.

Today, we can see astrolabes in museums, observatories and planetariums, such as the museum of *Arts et Métiers* or the Louvre in Paris, observatories of Paris or Greenwich, museums of the history of science of Geneva, Oxford or Firenze, maritime museums of Madrid or Barcelona, of the Adler planetarium of Chicago, etc.

The astrolabe had a strong influence on various arts and has become the symbol of exploration and scientific knowledge. Examples can be seen in painting, sculpture and even on stamps, money and watches, on the page [Astrolabes in arts](#). It is also not so rare to see an astrolabe and an armillary sphere in movies when a scientific lab is shown, such as with Dumbledore in *Harry Potter* or in the travelling bag of Guillaume de Baskerville in *The name of the rose*.

Astrolabes usually have drawings on their two faces (**front** and the **back**) whose purpose may be different and/or complementary.

## The front of the astrolabe

The front of an astrolabe is constituted with the **mater** (2) on which several mobile disks and accessories are installed. The mater can be suspended by a ring called the **throne** (not drawn here). The **limb** (1) is around the mater and is thicker. The mater, throne and limb are fixed with respect to each other. The mater has a hole in its center. **Plates** can be installed on the mater that are designed for a given latitude. An astrolabe is usually provided with at least three plates in addition to the mater which can contain also the same drawings. The **Rete** (3) is installed on top of the plate, then sometimes a **Ruler** (6).

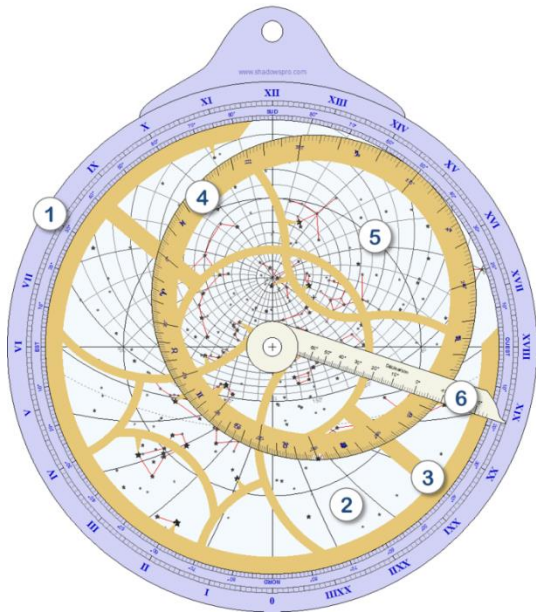

1. **The Limb** – is around the mater and scaled in degrees (90° quadrants) and in hour angles. It shows north, south, east and west points and is usually used with the ruler.
2. **The Mater** – can have the same drawings as a plate. The three circles are the two tropics and the equator. The drawings inside the horizon are azimuth and altitude arcs (almucantarats).
3. **The Rete** – can be rotated around the central axis. It is usually decorated with fine and rich details.
4. **The Ecliptic circle** – is scaled in ecliptic longitude and displays Zodiac symbols. It is part of the Rete.
5. **Stars of the celestial sphere** – can be drawn directly or may be replaced by small pointers attached to the Rete.
6. **The Ruler** – rotates around the center and points to a scale on the limb.

## The back of the astrolabe

The back contains several drawings and an **Alidade**. One usually starts by using the back of the astrolabe before using the front (for example to find the Sun's altitude with the back and knowing the date, assess the solar time on the front).

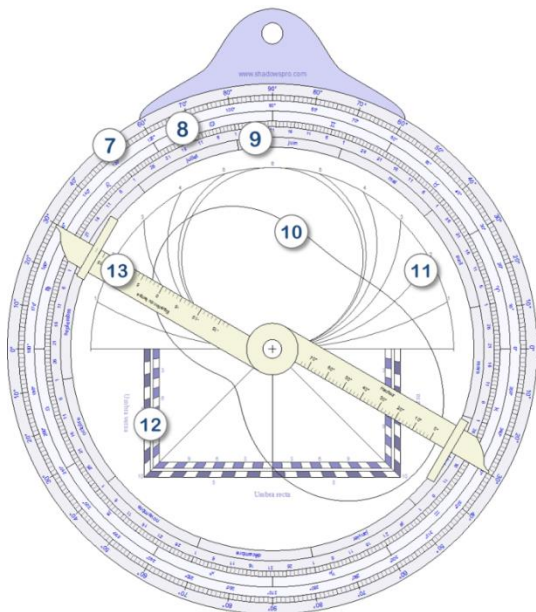

7. **Scales in degrees** – to measure altitudes or angles with the alidade.
8. **Scales in ecliptic longitude** – with Zodiac symbols.
9. **Calendar** – to find the ecliptic longitude of the Sun for a given date.
10. **Equation of time** – depending on the date.
11. **Unequal hours**.
12. **Shadow square** – to calculate distances and heights.
13. **Alidade** – used for sighting through with a pinhole on each end.

Some astrolabes may provide other drawings on the front or the back such as the [Qibla](#) for several locations, equal hours, etc.

## Different types of astrolabes

Across time, astrolabes have been improved and have evolved into many types:



*Classical Planispheric astrolabe*



*Universal astrolabe*



*Mariners astrolabe*



*Muslim Planispheric astrolabe*

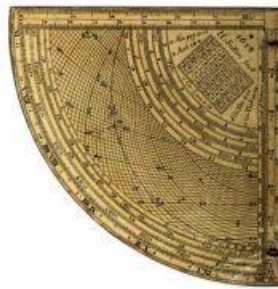

*Quadrant astrolabe*



*Rojas astrolabe*

All these astrolabes are described in D'Hollander's book (see bibliography).

Current version of Shadows offers the [Mariners astrolabe](#), the [planispheric astrolabe](#) and the [Universal astrolabe](#).

## The stereographic projection

The Stereographic projection, which is used in planispheric astrolabes, projects a point of a sphere onto the equatorial plane, as seen from one of the poles. For an astrolabe, the center of projection is the south pole for the northern hemisphere, and the north pole for the southern hemisphere.

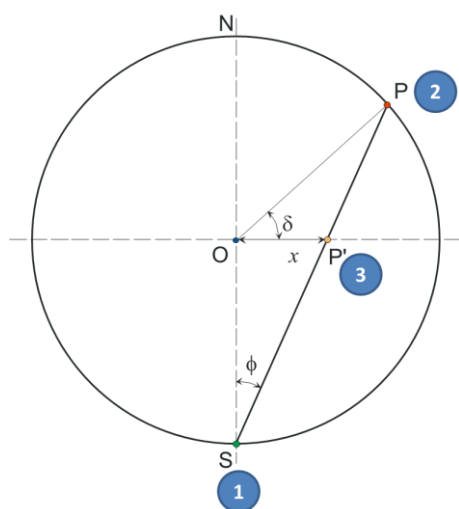

The center of projection (1) is the south pole. The point P on the celestial sphere (2) with a declination  $d$  is projected onto the equator as point P' (3). Its distance to the center is measured by  $x$ . This projection keeps the other coordinate, the right ascension  $a$ . The polar coordinate of point P' will be  $(x, \alpha)$ .

The lower the declination, the farther the projected point from the center O. This is the reason why the projection is limited to the southern tropic.

The stereographic projection has interesting properties for drawing maps:

- The projection of any circle of the sphere is also a circle on the projection plane
- The projection does not alter angles

also:

- The equator is projected onto itself as, by definition, it lays on the equatorial plane
- All circles of a given declination are projected as concentric circles with center O

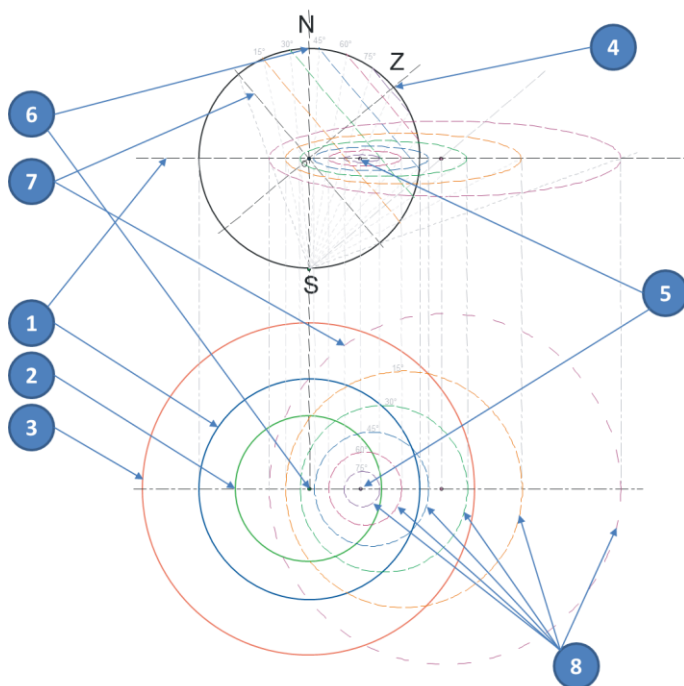

**1. The equatorial circle** – is projected onto itself.

**2. The Tropic of Cancer** – is projected onto a circle inside the equatorial circle.

**3. The Tropic of Capricorn** – if projected as a circle outside the equatorial circle. It limits the drawings of the astrolabe.

**4. The Zenith point** – is projected in 5 on the north-south line of the astrolabe, far from the center when the latitude is low.

**6. The North Pole** – is projected at the center of the astrolabe.

**7. The local horizon** – is projected as a large circle shifted from the center.

**8. Altitude circles above the horizon** – are projected as shifted circles called almucantarats.

## The Planispheric astrolabe

The planispheric astrolabe is so called because it is the projection of a sphere on a plane. It uses the stereographic projection, which projects the sphere onto the equatorial plane from a pole.

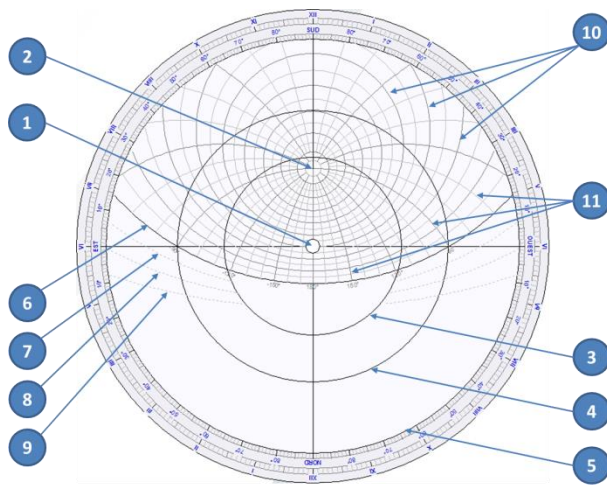

1. **North Pole** – is at the center of the astrolabe.
2. **Zenith** – which depends on the latitude for which the plate is designed.
3. Circle of the **Tropic of Cancer**
4. **Equatorial circle**
5. Circle of the **Tropic of Capricorn** – that defines the limits of the astrolabe.
6. **Horizon circle.**
7. **Civil twilight arc.**
8. **Nautical twilight arc.**
9. **Astronomical twilight arc.**
10. **Altitude circles** above the horizon – also called Almucantarats.
11. **Azimuth circles.**

From left to right, plates designed for the following locations: Madras, India, latitude 13°, Alexandria, Egypt, latitude 31°, Delft, The Netherlands, latitude 52°, Tromsø, Norway, latitude 69°.

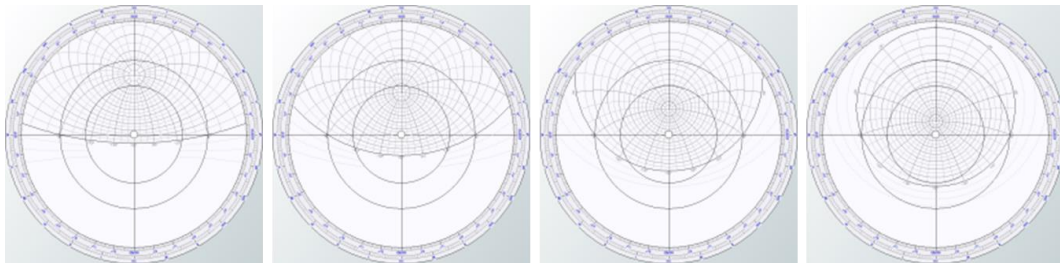

### Rete of the astrolabe

The rete of an astrolabe represents the ecliptic circle and the celestial sphere with stars and constellations, on a transparent disk or a metallic ornamented support that is superimposed on the plate. The ecliptic circle is scaled with the Sun's ecliptic longitude and with zodiac symbols.

The rete can be drawn transparent to allow a clear reading of the plate underneath. Old retes are made in metal with pointers for stars. Shadows can draw both types of retes.

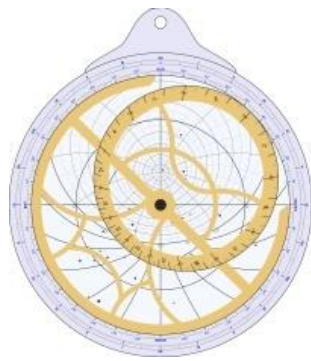

*Opaque rete*

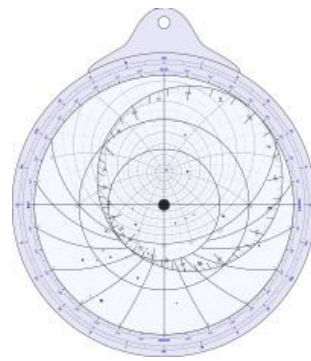

*Transparent rete*

The transparent version can be used if you want to print it on Plexiglas or on a transparent film. The opaque version is closer to what can be seen on old astrolabes with pointers for stars as below:

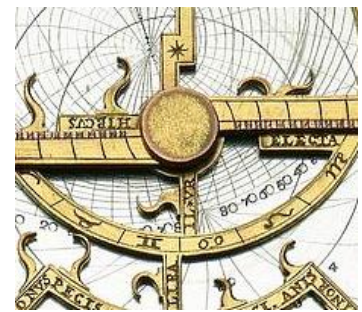
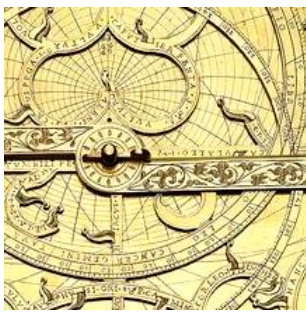

## Rotating the rete

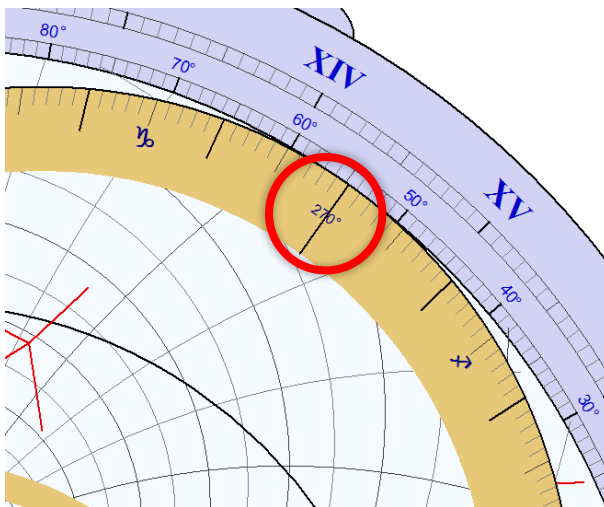

The rete can be rotated on screen with the mouse by clicking on the area around 270°. You can then move it to align a given position on the ecliptic circle with the limb or the scales on the plate.

The rete can also be rotated using arrows on the keyboard, up arrow  $\uparrow$  and down arrow  $\downarrow$  and holding the CTRL key pressed.

The rotation is performed by 1-degree increment.

## Examples of ancient retes

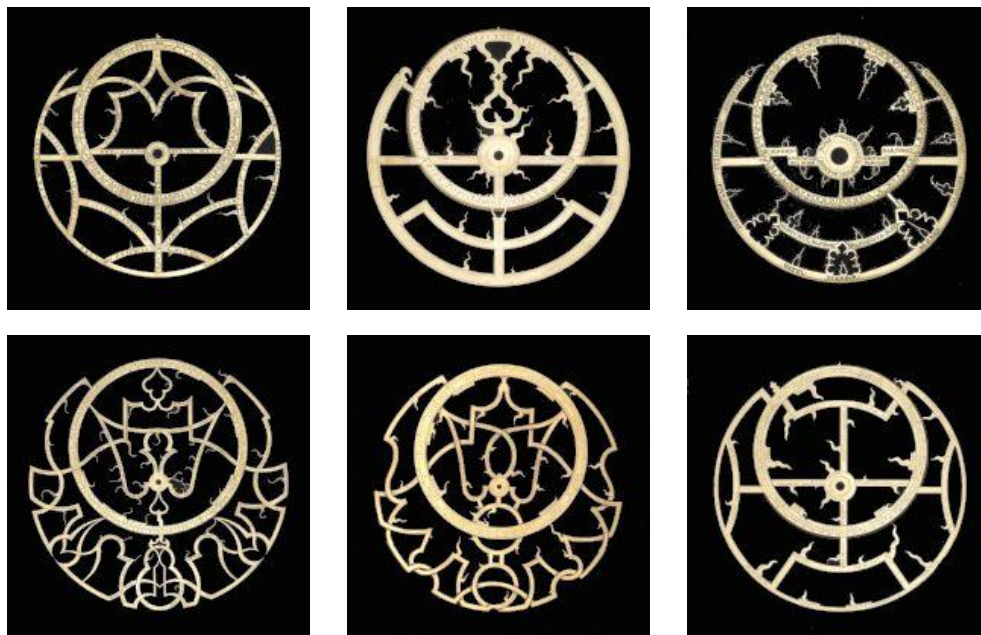

Photos, © National Maritime Museum, Greenwich, UK

## Configuring the drawing of the astrolabe



Display the front side of the astrolabe



Display the back side of the astrolabe



Change the diameter of the astrolabe and the thickness of the limb



Change the latitude of the plate

## On the front



Display the limb



Display the altitude circles and the azimuth arcs on the plate



Display the equator and Tropic circles on the plate



Display unequal hours



Display the opaque rete



Display the transparent rete



Display stars and constellations



Display the ruler on the astrolabe







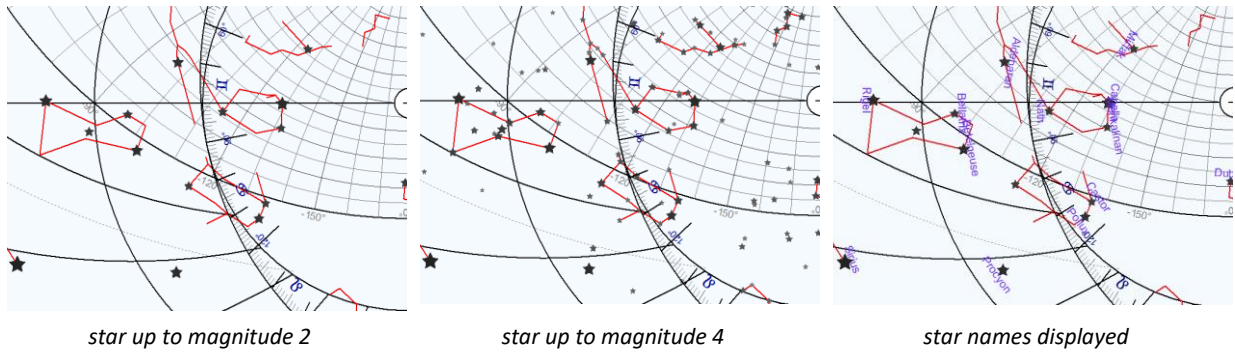

Change colors of elements

Other options can be accessed from the [Drawings](#) menu, in particular scaling options for the limb and the plate. Stars can be displayed from up to magnitude 1 to up to magnitude 4, and star names can be displayed.



Star pointers can be displayed on the opaque rete, as on ancient astrolabes.

### On the back

-  Display the back
-  Display a calendar on the limb
-  Display the arcs of unequal hours
-  Display the shadow square
-  Display the equation of time
-  Display the alidade

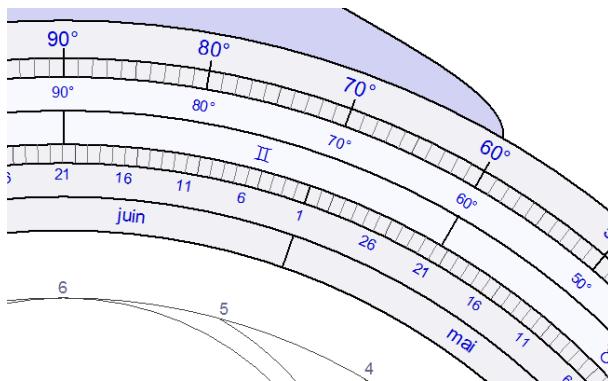

The calendar drawn on the limb is scaled from the inner edge to the outer edge with the following indications:

- months
- days
- zodiac signs
- Sun's ecliptic longitude
- quarters of circles scaled in degrees

The alidade is scaled on both sides for two different uses:

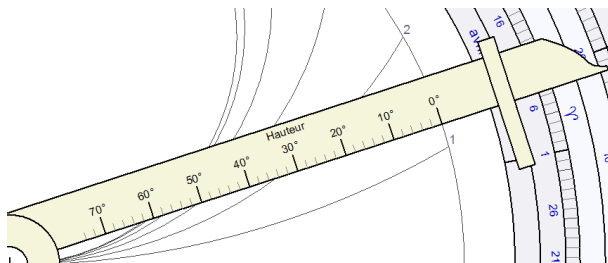

On one side, with degrees of altitude to read arcs of unequal hours in function of the date pointed on the calendar on the limb.

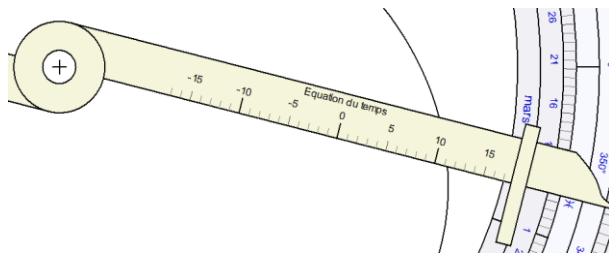

On the other side, with minutes to read the equation of time in function of the date pointed on the calendar on the limb.

The planispheric astrolabe is available only in [Shadows Pro](#).

## Astrolabe for the southern hemisphere

It is possible to create an astrolabe for the southern hemisphere, by entering a negative latitude for the plate when creating the sundial in Shadows. The stereographic projection is then carried out from the north pole onto the equator and the plate corresponds to the southern sky seen from above the south pole of the celestial sphere.

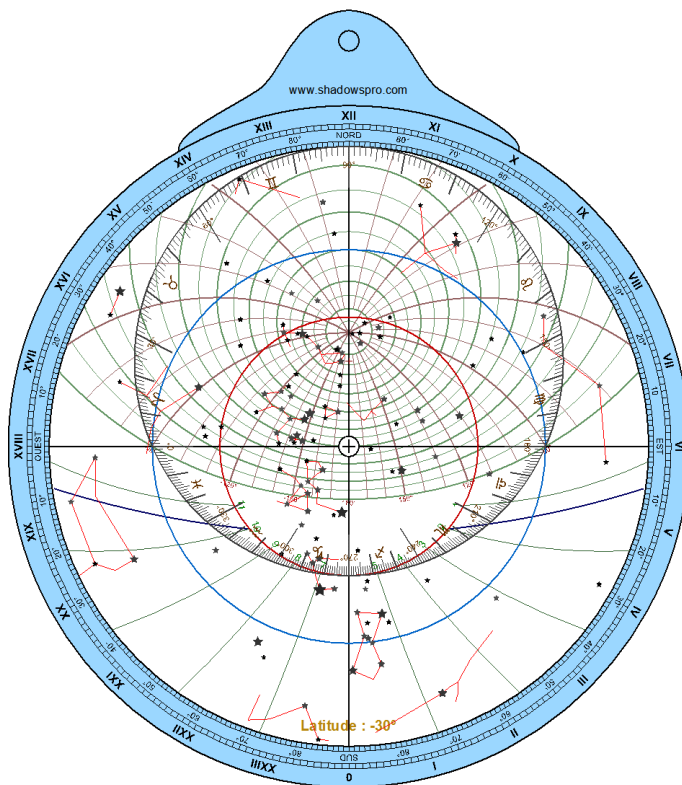

The limb and the ecliptic circle are reversed. The plate displays stars and constellations of the southern sky.

Very few southern astrolabes exist in the world, but Shadows makes it easy to simulate and create them. Hopefully users will realize their own ones.

## How to build an astrolabe

Building an astrolabe is slightly more complex than building a sundial. But Shadows makes it possible to prepare all the required elements.

An astrolabe can be seen as a stack of layers made of disks, rings and rulers. Each element must be prepared separately by printing the corresponding drawing and replicated it on an adequate material. Elements that can be printed are:

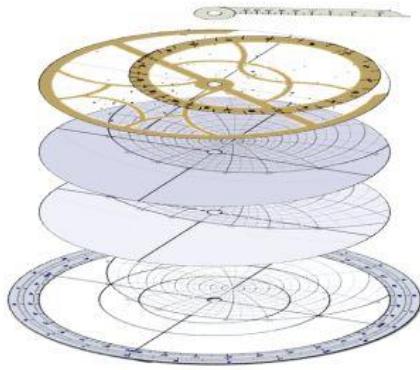

- The matter and a plate on the background. The plate is designed for a given latitude.
- The limb.
- Other plates of higher or lower latitude, spaced by  $5^\circ$  for example. Plates can be printed on both sides of a disk to save weight.
- The rete.
- The ruler.
- The back.
- The alidade for the back.

## List of problems solved with a planispheric astrolabe

### Determine the hour and direction of the sunrise (or sunset), at a given date

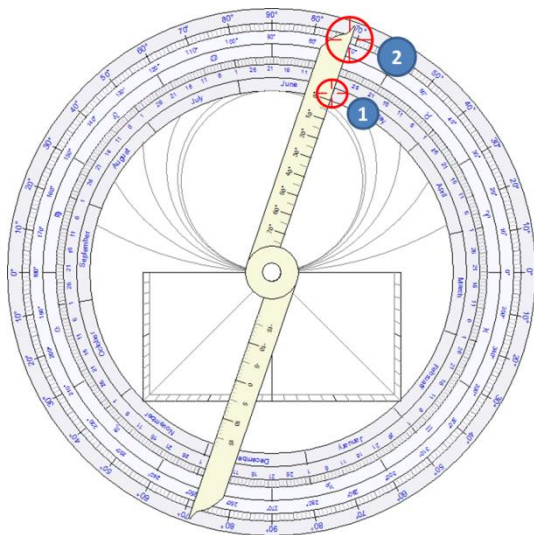

Let's take an example for Paris (latitude  $48^\circ 50'$  N) on June 1<sup>st</sup>.

We first find the ecliptic longitude of the Sun at this date, by rotating the alidade, on the back, to June 1<sup>st</sup> (1)

This corresponds to an ecliptic longitude of  $71^\circ$  (2), or Gemini 11°.

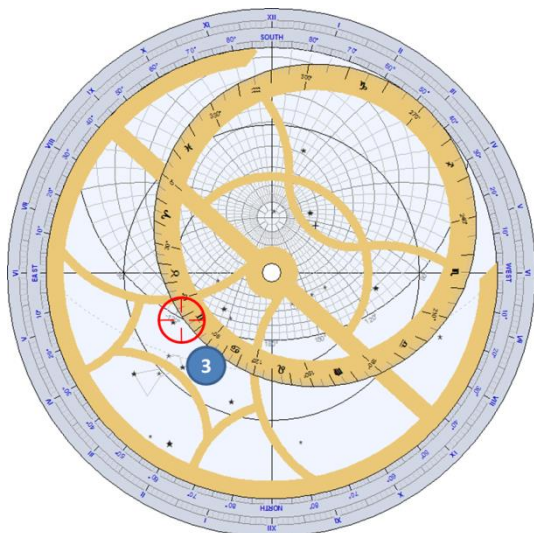

Then on the front of the astrolabe, rotate the rete to bring the mark  $71^\circ$  of the ecliptic circle onto the horizon, on the sunrise side (3).

To find the hour of the sunset, use the other side of the horizon, on the right of the astrolabe.

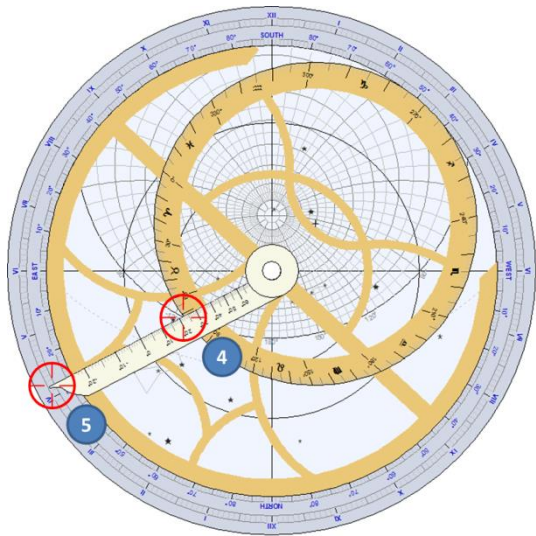

Rotate the ruler to the same point on the horizon (4).

You can now read the hour of sunrise on the limb (5), here approximately 4h10.

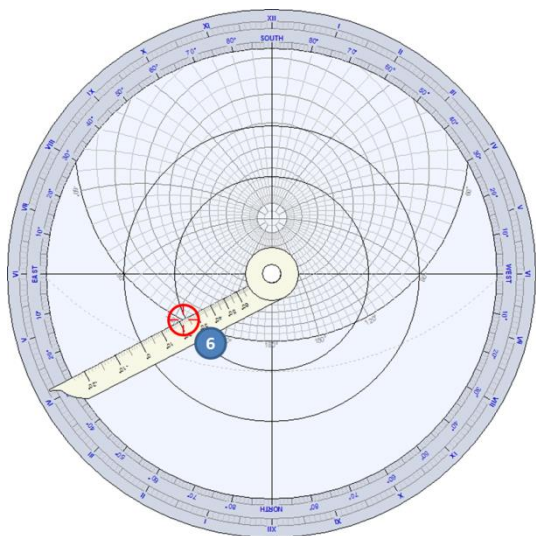

The azimuth of sunrise is read by looking the azimuth arc ending to the horizon (6), here around 125° east of south (*i.e.*, 35° north of east).

### Determine the instant when the Sun will have a given Azimuth, at a given date

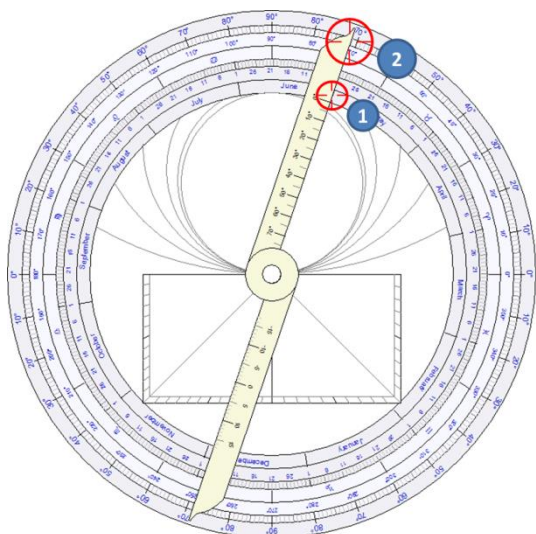

Let's take again the Paris example, on June 1st (see previous exercise). At what time will the Sun be at azimuth 30°, east from south?

Let's find the ecliptic longitude for this date, by rotating the alidade on the back of the astrolabe to point June 1<sup>st</sup> (1).

The ecliptic longitude is (2): 71°, or 11° in Gemini.

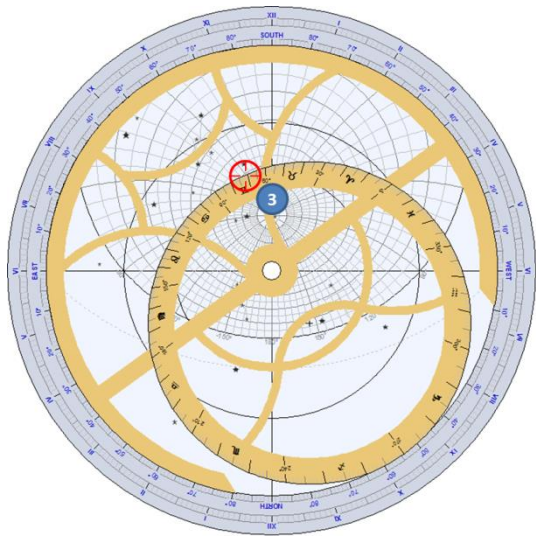

On the front of the astrolabe, rotate the rete to bring the mark  $71^\circ$  on the ecliptic circle to the arc of azimuth  $30^\circ$  (3).

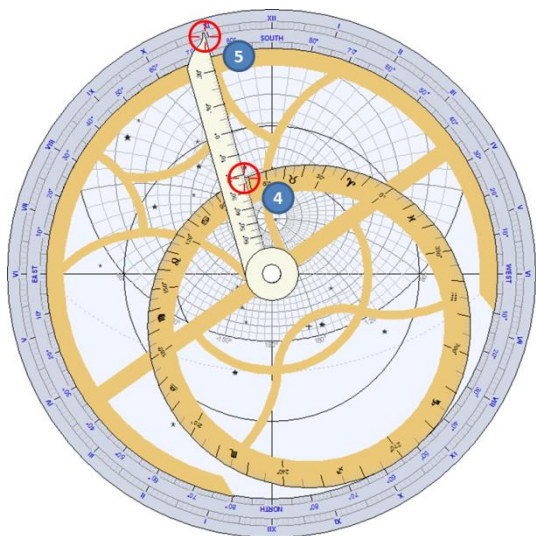

Then rotate the ruler to the intersection between the ecliptic circle and the azimuth circle of  $30^\circ$  (4)

Solar time can be read on the limb (5), here around 10h55 am.

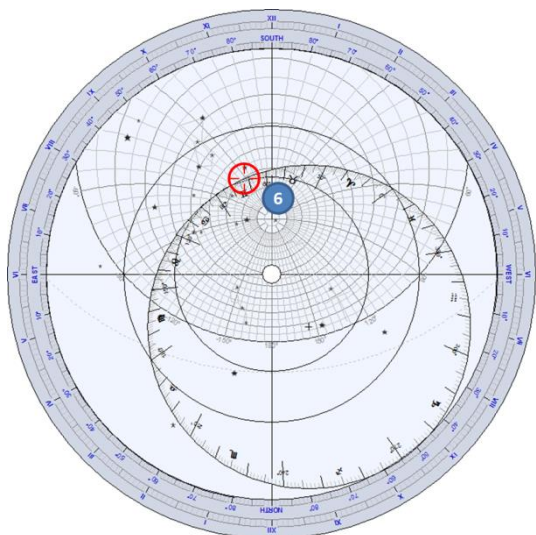

We can also determine that the altitude of the Sun at this moment is a bit more than  $60^\circ$  (6).

## Determine the instant when the Sun will have a given Azimuth and Altitude

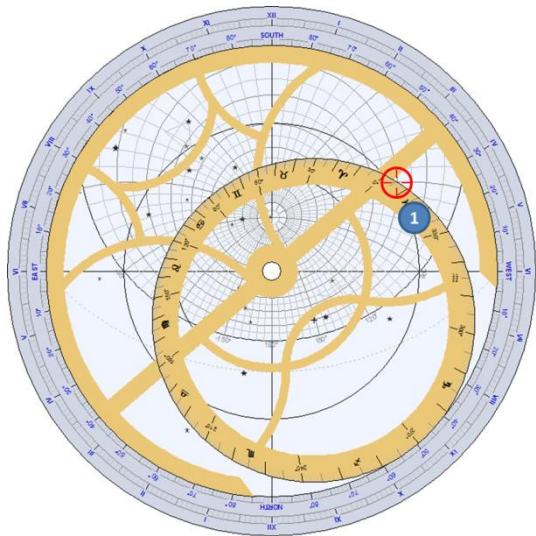

Let's consider an astrolabe built for Prague, Czech Republic (latitude 50° 05' N). When will the Sun be at an azimuth of 60° west and an altitude of 20°?

Rotate the rete to bring the ecliptic circle at the intersection of the azimuth arc 60° west and the altitude circle 20° (1).

This point has an ecliptic longitude of about 6°.

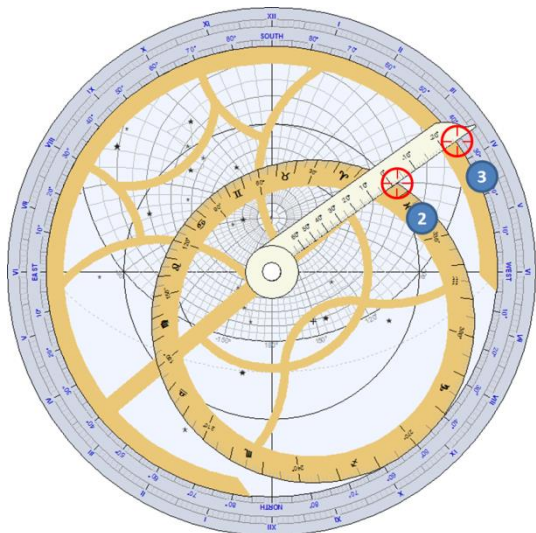

With the ruler aligned on this point (2), one can read solar time on the limb (3), here between 3h35 and 3h40 in the afternoon.

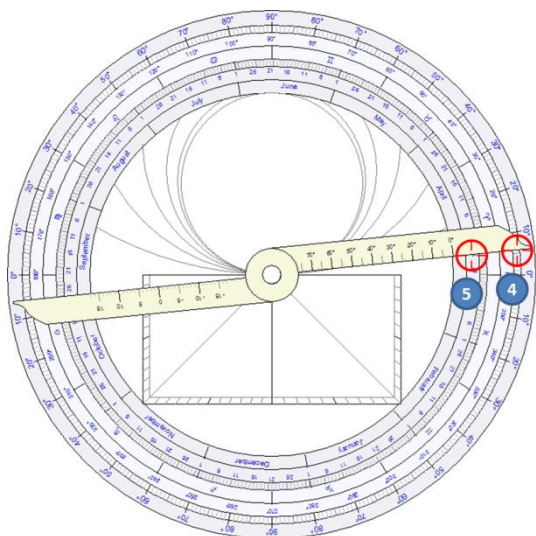

On the back of the astrolabe, rotate the alidade to point 6° of ecliptic longitude (4)

The date is read on the inner ring (5), here March 26<sup>th</sup>.

Determine the hour of rise (or set) of a star on the rete, at a given date

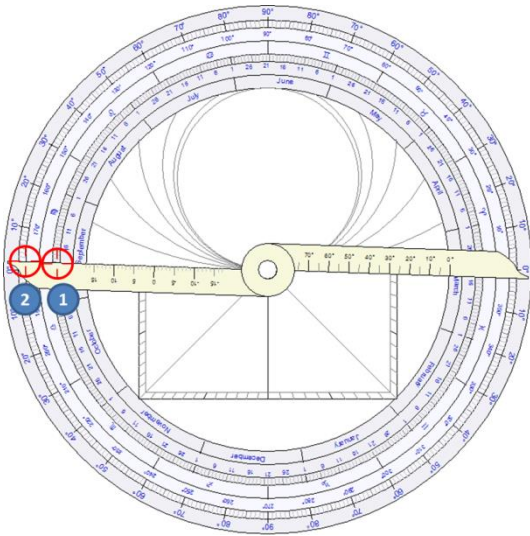

Let's consider an astrolabe built for Casablanca, Morocco (latitude  $33^{\circ} 39' N$ ). At what time will the star Vega (in the constellation Lyra) set on the horizon, on September 21<sup>st</sup>?

On the back of the astrolabe, rotate the alidade to point September 21<sup>st</sup> (1).

The ecliptic longitude is read, around  $178^{\circ}$  (2).

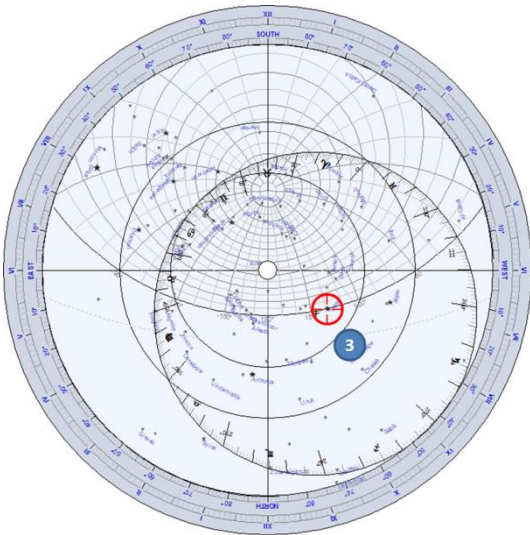

On the front of the astrolabe, rotate the rete until Vega is on the horizon, on the evening side (3).

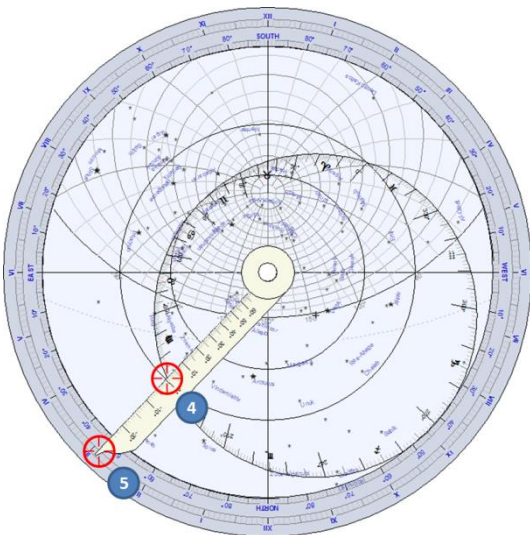

Rotate the ruler to point  $178^{\circ}$  of ecliptic longitude (4).

Read solar time on the limb (5), here around 2h55 a.m.

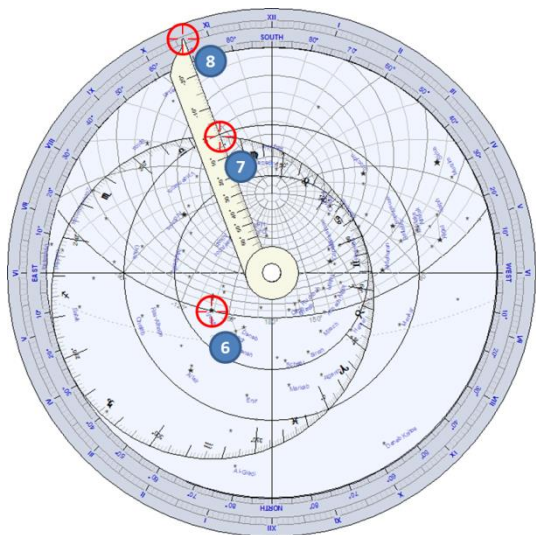

To find the rising hour of the star, move Vega to the other side of the horizon (6).

Move the ruler to 178° of ecliptic longitude (7).

Read solar time on the limb (8), here between 10h35 and 10h40 a.m.

### Determine the instant of culmination of a star on the rete, at a given date

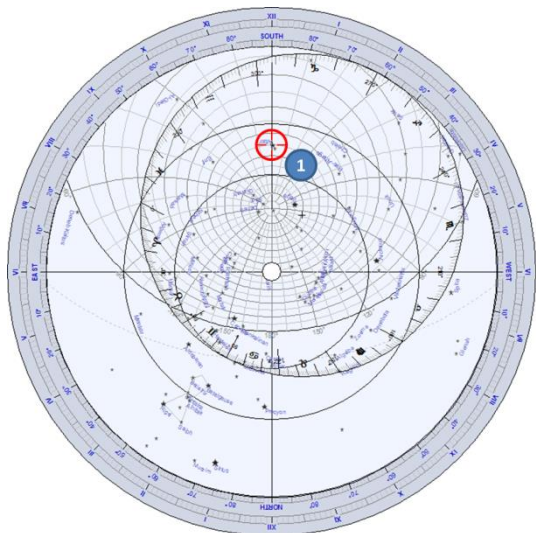

Let's consider an astrolabe built for Firenze, Italy (latitude 43° 46' N). At what time will the star Altair (in the constellation of Aquila) culminate above the horizon, on September 21<sup>st</sup>?

On the back of the astrolabe, we find that the ecliptic longitude for this date is 178°, by using the same method seen as the previous exercise.

On the front of the astrolabe, rotate the rete to move Altair on the meridian line, between the pole and south (1).

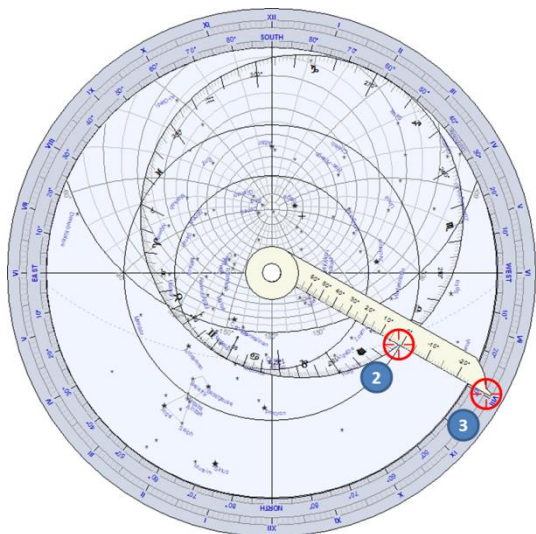

Rotate the ruler to 178° of ecliptic longitude (2).

Then read solar time on the limb (3), here between 7h55 and 8h in the evening.

### Determine the maximum altitude of the Sun over a year for a given location

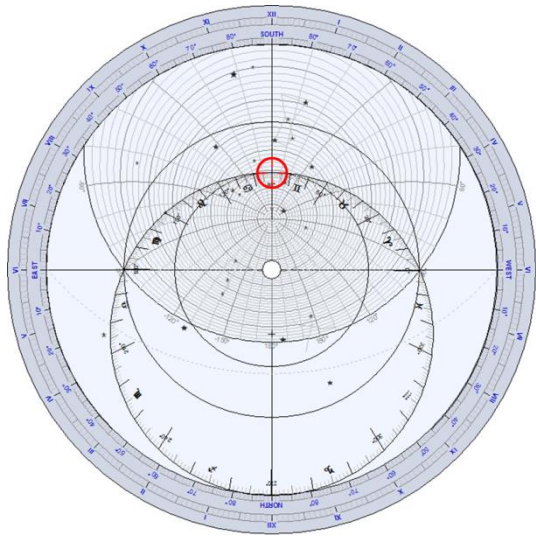

Let's consider an astrolabe built for Delft in Netherlands (latitude 52° 00' N).

Bring the mark 90° of the ecliptic circle to the meridian line, and read the corresponding altitude on the almicantarats (altitude circles).

The 90° mark is the point where the ecliptic is tangent to the Tropic of Cancer, which corresponds to the summer solstice in the northern hemisphere.

Here we read around 62° of altitude.

The exact value can be calculated by  $90^\circ - 52^\circ + 23.5^\circ = 61.5^\circ$

### Determine the maximum altitude of the Sun on November 12<sup>th</sup> for a given location

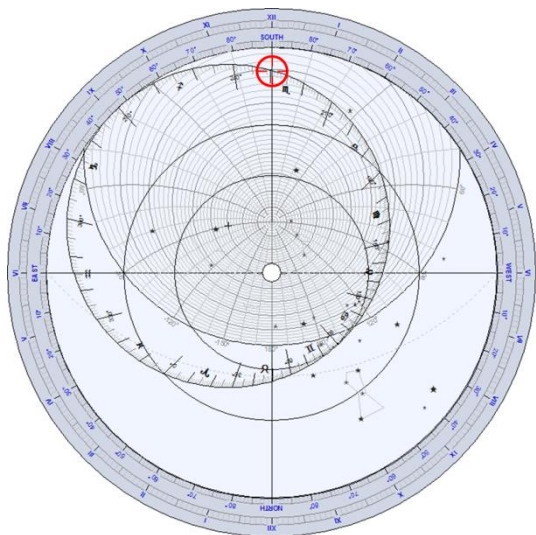

Let's take the same astrolabe as the previous exercise.

On the back of the astrolabe, we find that the ecliptic longitude on November 12<sup>th</sup> is 229.5°

On the front of the astrolabe, bring the 229.5° mark of ecliptic longitude to the meridian line and read the corresponding altitude on the almicantarats.

Here we read a bit more than 20° of altitude.

### Determine the maximum altitude of a star at a given date, for a given location

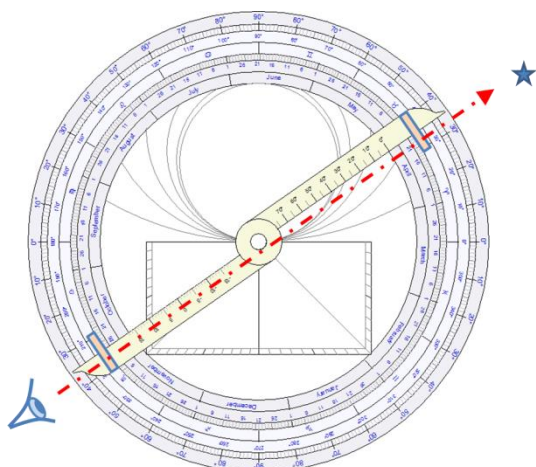

Let's take an astrolabe built for Cairo, Egypt (latitude 30° 02' N).

On the back of the astrolabe, we use the alidde and the two pinholes to point a star. The astrolabe must be hung by the ring of the throne, vertically. Let's point to the star Sirius. We measure for example its altitude at 35°.

Then we find that the ecliptic longitude on April 20<sup>th</sup> is around 30°.

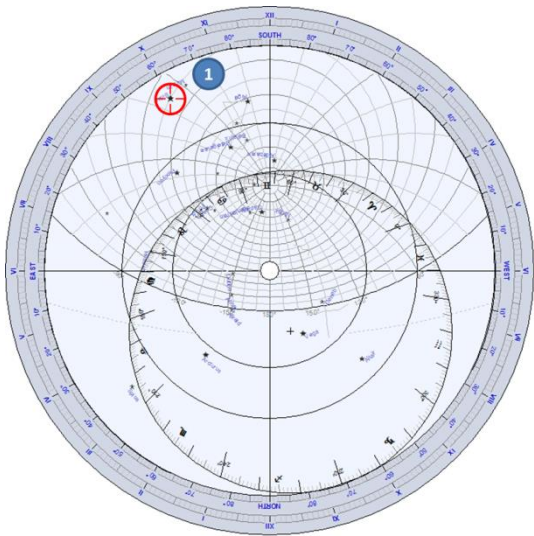

On the front of the astrolabe, rotate the rete to bring Sirius on the azimuth circle of 35° (1).

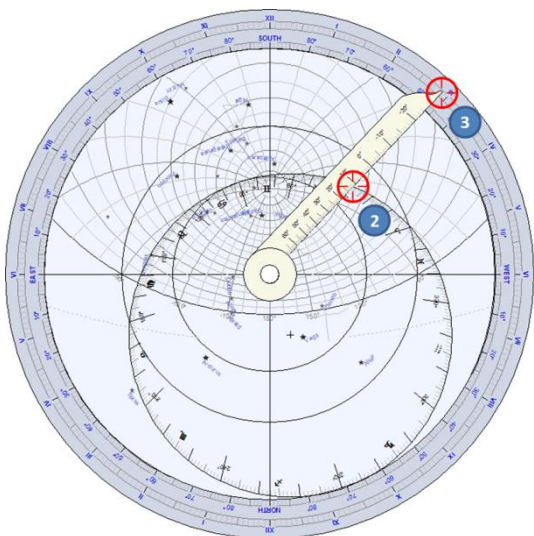

Then rotate the ruler to point 30° on the ecliptic circle (2).

We read solar time on the limb at the end of the ruler (3), here around 2h55 p.m.

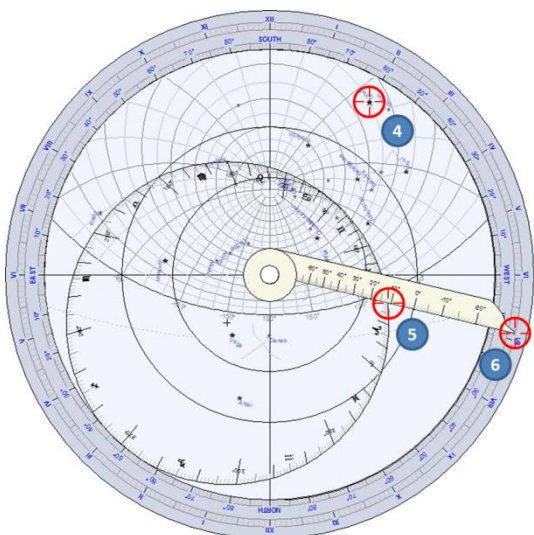

This problem has a second solution, if we bring Sirius on the other intersection with the 35° circle (4). Rotate the ruler to 30° on the ecliptic (5), and read the hour 4h55 (6).

## Determine the right ascension and declination of a star

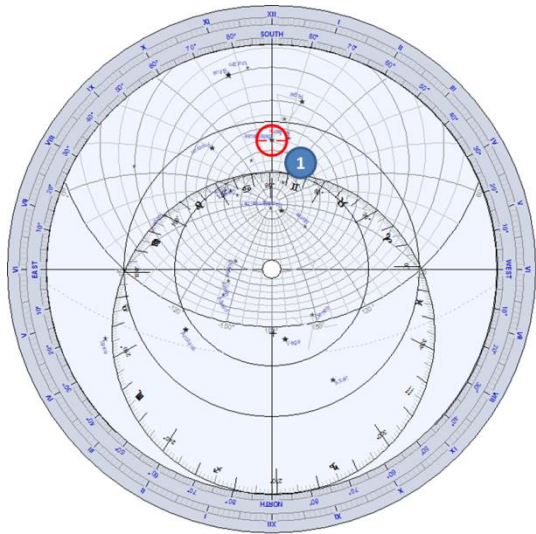

Let's consider an astrolabe built for Boston, USA (latitude  $42^{\circ} 21' N$ ).

We will find the right ascension and the declination of Betelgeuse (in the constellation of Orion).

Rotate the rete to bring the star on the meridian line (1).

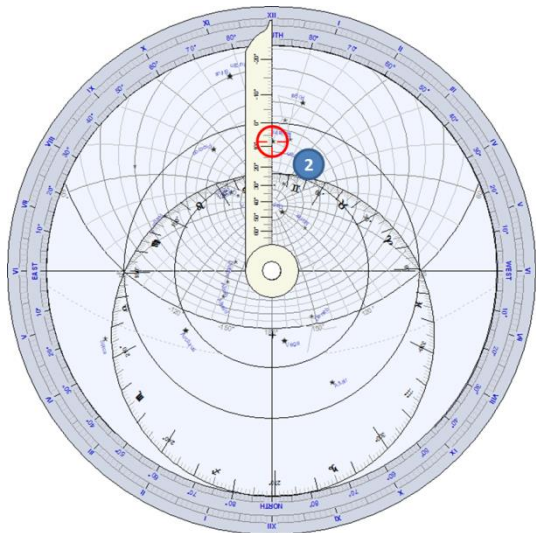

Align the ruler with the star and read its declination on the ruler marks (2), here approximately  $8^{\circ}$ .

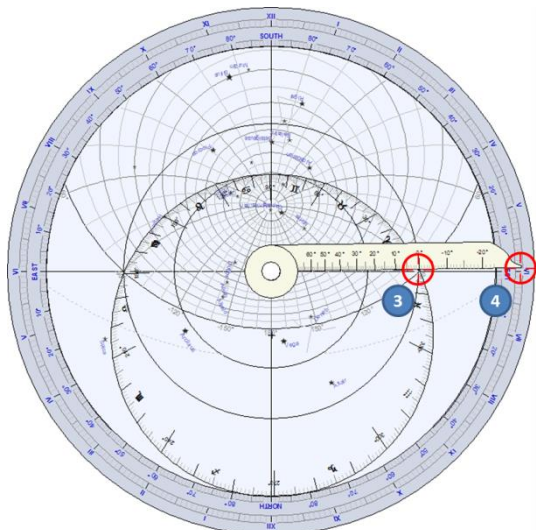

The right ascension is given by the direction of the vernal point (Aries  $0^{\circ}$ ). Rotate the ruler to the ecliptic longitude  $0^{\circ}$  (3), and read the right ascension on the limb (4), here around 5h 55'.

The precise coordinates of the star are:

$$\alpha = 5 \text{ h } 55'$$

$$\delta = 7^{\circ} 25'$$

## The universal astrolabe

The universal astrolabe makes it possible to solve the major drawback of the planispheric astrolabe which works only for a given latitude. Ancient astrolabes used to be shipped with a set of plates for several latitudes every 5°.

The universal astrolabe can be used for any latitude.

Shadows offers the [Saphae Arzachelis](#) which was invented in the 11th century by the Andalusian astronomer, Arzaquiel. In this astrolabe, the stereographic projection is not made from the pole on the equatorial plane but from the vernal point on a plane crossing both poles.

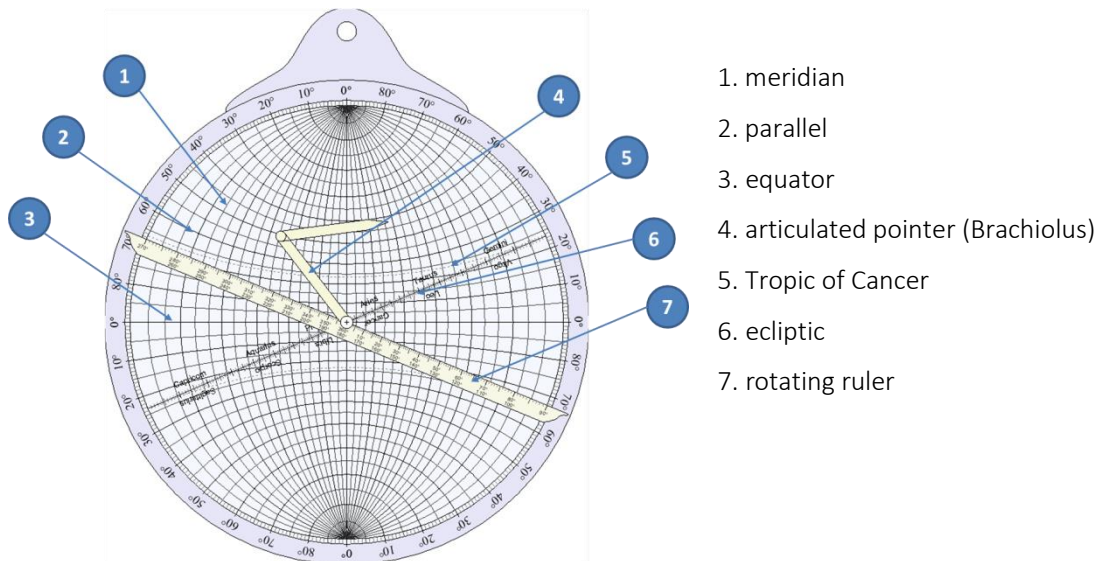

**The ruler** – The ruler can be rotated on screen using the mouse by clicking on one of its ends at 90° or 270°. It is scaled in degrees of ecliptic longitude.

**The pointer** – also called [Brachiolus](#), can be moved on screen by dragging its end with the mouse. It is made of two parts that move with the ruler.

The universal astrolabe is usually used to convert coordinates. See also the [List of problems solved with a universal astrolabe](#).

The universal astrolabe is available only in [Shadows Pro](#).

## List of problems solved with a universal astrolabe

### Convert coordinates between ecliptic and equatorial systems

The universal astrolabe allows the immediate conversion of coordinates.

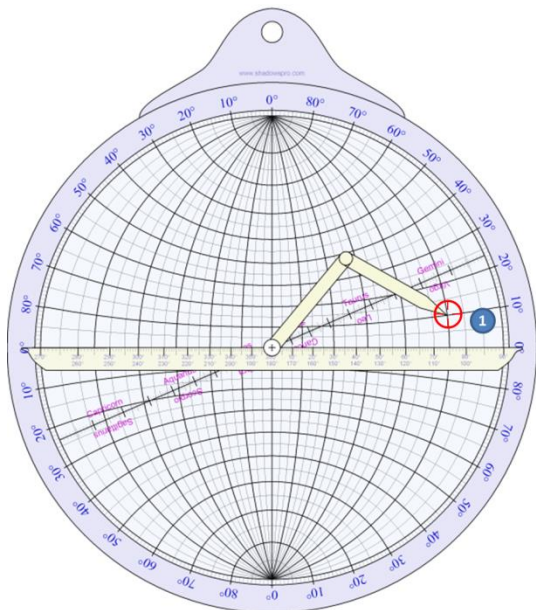

To convert ecliptic coordinates to equatorial coordinates, you have to put the ruler horizontally and point the coordinate with the Brachiolus (articulated arm).

For example, (1), coordinate 75° of longitude and 10° of ecliptic longitude.

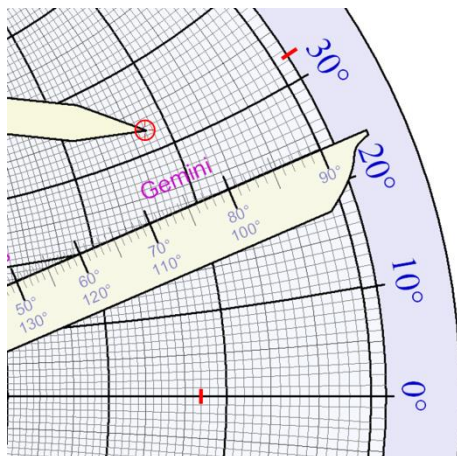

Bring the ruler on the ecliptic.

The right ascension can be read with meridians and declination with parallels. Here, we read 72° of right ascension (or 4 h 48 min), and 32° of declination.

## The mariners' astrolabe

The mariners' astrolabe is mainly offered as an aesthetic object as it is not used for calculations, except for measuring angles (horizontal or vertical).

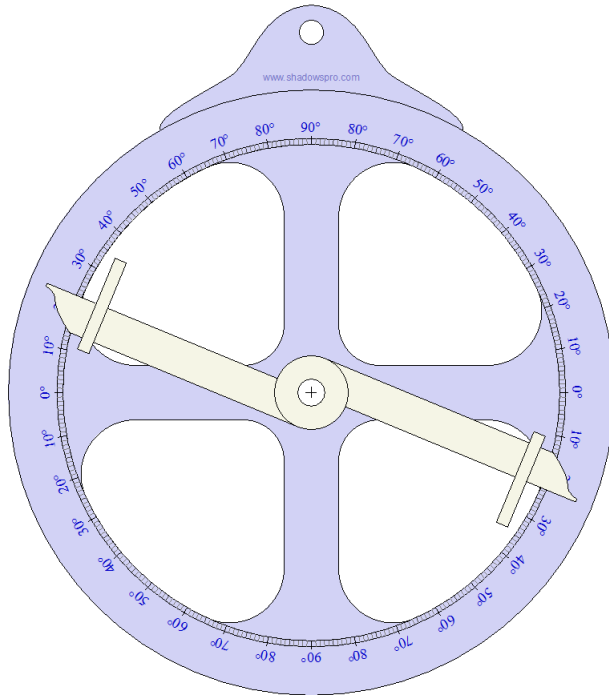

The alidade has two small holes used to sight a star or a point on the horizon. The two holes need to be aligned with the center of the astrolabe (they have to be on a diameter)

The angle is read on the limb.

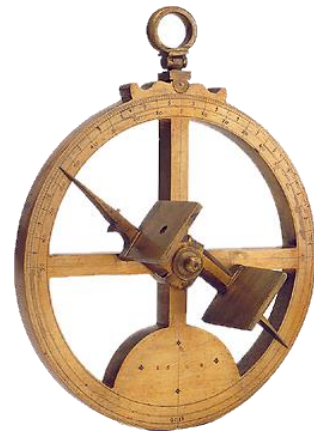

*Photo: Museum of history of science, Oxford*

The mariners' astrolabe is available in [Shadows Expert](#) and [Shadows Pro](#).

*This page is left intentionally blank*

## PART 4 – OTHER GNOMONIC AND ASTRONOMICAL FEATURES

### The equation of time

#### Origin of the equation of time

Shadows use by default the French convention for the equation of time: it is defined as the difference between the mean time and solar time (see below).

The equation of time provides the time difference between **solar time** and **mean time**. Solar time is given by the Sun's hour angle; mean time is given by the division of a day by 24 hours of 3600 seconds (the second is a primary quantity defined from the light speed). Therefore, solar time is not synchronized with mean time, because of variations of astronomical origin.

From one day to the next, the Earth has progressed in its orbit and the direction of the Sun has slightly changed (see the figure below). This variation is not constant over the year as the orbital speed varies with the distance to the Sun (the orbit is elliptical).

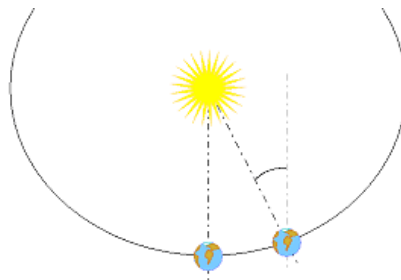

In addition, the Earth's axis is inclined with respect to the ecliptic plane (the apparent orbit of the Sun). The projection of its position on the celestial equator introduces another periodical variation.

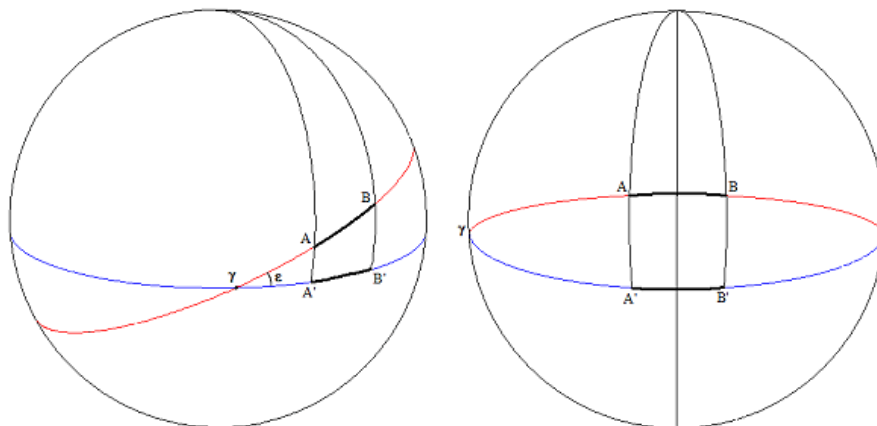

*The ecliptic plane (red) is inclined on the celestial equator (blue) by around 23°. The A-B arc, travelled by the apparent Sun is projected in A'-B'. When the Sun is close to the vernal point (g) the A'-B' arc is shorter than the A-B arc (left above figure). This is the case around the equinoxes. When the Sun is close to its maximum declination, around the solstices (right above figure), the A'-B' arc is longer than the A-B arc.*

These two phenomena are at the origin of the equation of time. They are superimposed and give the familiar double-sinusoidal shape of the curve.

## Convention used for the equation of time

Two conventions are used for the equation of time: **mean time - solar time** (the convention in Shadows) or **solar time - mean time** (the convention in most English books). The later reverses the curve but the values are to be used in an opposite manner, so that the result is the same.

This convention may be chosen in the preferences [Equation of time](#).

The following table explains how to use the value of the equation of time (EoT) given by the program depending on the convention:

	<b>MT – ST *</b>	<b>ST – MT</b>
To get solar time from mean time	subtract the EoT	add the EoT
To get mean time from solar time	add the EoT	subtract the EoT

\* Default value used in Shadows.

Note: adding a negative number is equivalent to subtracting this number without its sign (12 plus (-5) equals: 12 minus 5 = 7). Subtracting a negative number is equivalent to adding this number without its sign (12 minus (-5) equals: 12 plus 5 = 17).

## Using the equation of time

The following explanation is given for the convention used in Shadows (MT-ST) and in parenthesis for the opposite convention (ST-MT). When the equation of time is positive (negative), the length of the day (time difference between two crossings of the meridian) is greater than 24 hours. In this case the True Sun (defining the solar time) is late compared to the mean Sun. The difference can be as much as +/- 15 minutes depending on the date. This difference is not negligible at all! It sometimes puzzles people looking at a sundial because the difference with the clock time is significant (a lot of people in Europe think that they just need to add 1 hour during the winter and 2 hours during the summer to the solar time to get the clock time).

Values of the equation of time are slightly different from one year to the next. That is why it is calculated for the reference year, which can be changed in the  [General preferences](#) by clicking on the [Reference](#) icon. After four years, the values become the same again. Therefore, the equation of time can be calculated for a given year or as a mean of four years.

## Graph of the equation of time

This graph shows values of the equation of time, in minutes (ordinates) as a function of the date (abscissa). The month is given in Roman numerals, the day of the month is graduated every ten days (1, 11, 21). The equation of time contains two periodical terms, one being twice as fast as the other. You can notice that the equation of time crosses the zero axis four times a year.

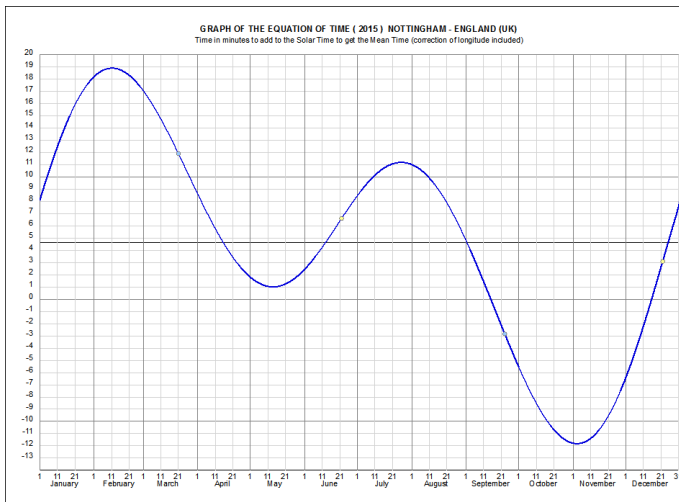



The value read from this graph is added to the solar time to get the mean time or subtracted from the mean time to get the solar time.

To get an accurate value of the equation of time for a given date, you have to use the table of the equation of time or the ephemeris.

This curve can include the longitude correction by activating the  **General preferences > Equation of time > Include the longitude correction**. The color of the curve can also be changed in this preference.

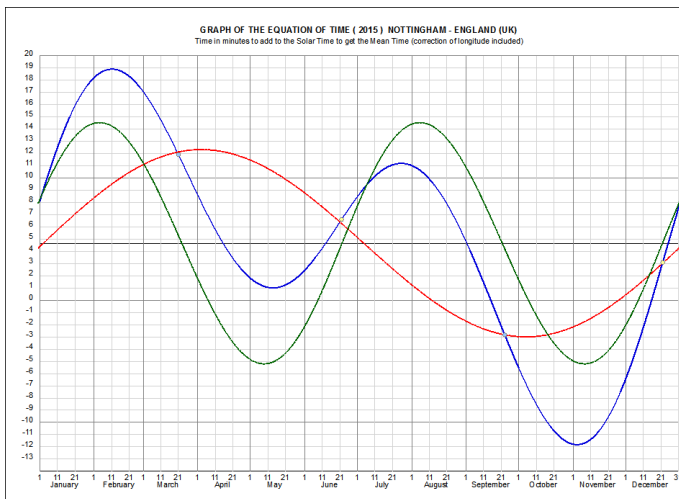
This graph can be printed and installed beside a sundial to provide a way to correct the solar time read on the sundial.



The two components of the equation of time can be superimposed on the general curve by clicking on the  icon.

The two components are the **obliquity of the ecliptic** (green curve) and the **eccentricity of the Earth's orbit** (red curve).

## Graph by months

This graph displays the equation of time split by month in order to provide better accuracy.

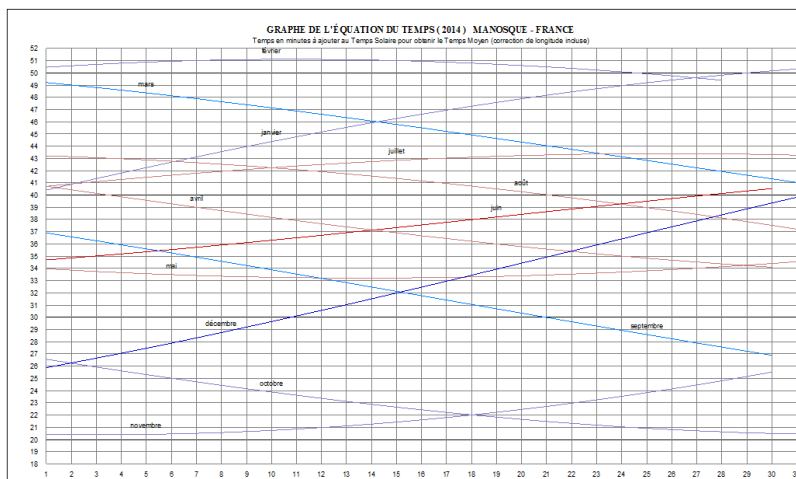

## Vertical graph of the equation of time

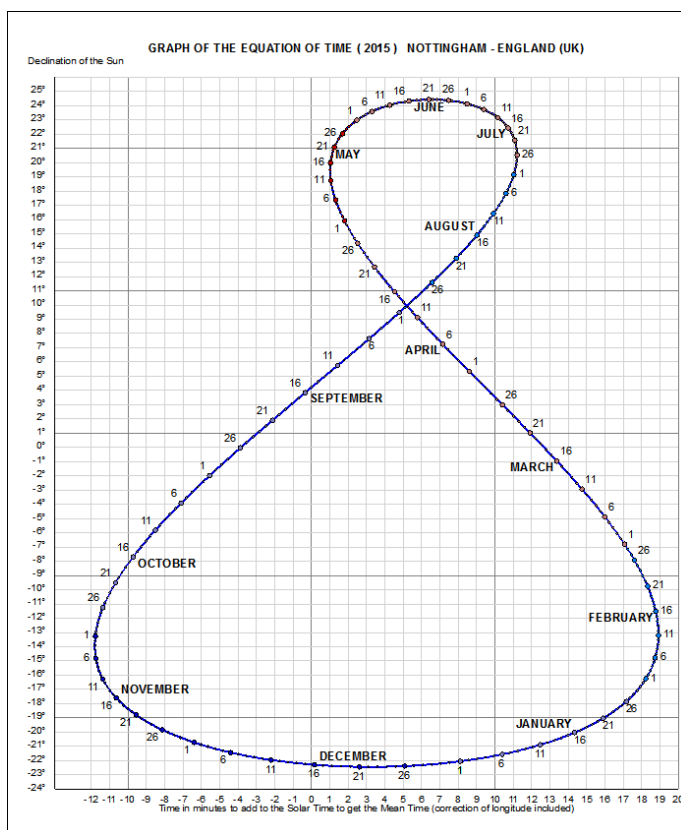

This graph shows the declination of the Sun (ordinates) as a function of the value of the equation of time (abscissa). The curve has a figure-8 -shape which is obtained by folding the graph of the equation of time as a function of the date.

The date is provided next to the curve, marked every day by a point, and a number every five days.

This graph provides two pieces of information when you know the date: the value of the equation of time, and the Sun's declination.

# Solar ephemeris

An ephemeris is a set of astronomical data calculated for a given date. The data provided here are related to the time of the position of the Sun.

Solar ephemeris is available in [Shadows Expert](#) and [Shadows Pro](#).

## General ephemeris

Ephemeris	
<b>General Data</b>	
Location	AIX-LES-BAINS, FRANCE
Latitude	45° 42' 00" North
Longitude	5° 55' 00" East
Time Zone	UT + 1 h
Correction of Longitude	36 min 20 s (36.3333 min)
Civil time - Solar time	40 min 36 s (0.67661 h)
<b>Annual Data</b>	
Year	2017
Date of the March's Equinox	20 March @ 10 h 30 min 01 s (UT)
Date of the June's Solstice	21 June @ 4 h 25 min 13 s (UT)
Date of the September's Equinox	22 September @ 20 h 02 min 38 s (UT)
Date of the December's Solstice	21 December @ 16 h 29 min 21 s (UT)
Duration of Winter	88 d 23 h 44 min 33 s (88.989271 d)
Duration of Spring	92 d 16 h 55 min 12 s (92.705000 d)
Duration of Summer	93 d 15 h 37 min 25 s (93.650984 d)
Duration of Fall	89 d 21 h 26 min 43 s (89.893553 d)
Duration of the longest Day	15 h 42 min 41 s (15.711355 h)
Duration of the shortest Day	8 h 40 min 34 s (8.676076 h)
Date of passage at Perihelion	4 January @ 10 h 56 min (UT)
Sun's Distance at Perihelion	0.983302085 A.U. (147099898 km)
Date of passage at Aphelion	4 July @ 0 h 55 min (UT)
Sun's Distance at Aphelion	1.016700220 A.U. (152096187 km)
Obliquity of Ecliptic	23° 26' 13" (23.437015°)
Eccentricity of Earth's orbit	0.016701272
Date of Easter	16 April
Qibla (direction of Mecca)	60° 09' (East of South)

General ephemeris is calculated for the [Reference date](#) chosen in the [Preferences](#) and for the [Reference location](#) chosen in the  [Tools](#) menu > [Edit the location database...](#)

This ephemeris provides the precise dates of solstices and equinoxes, duration of seasons, duration of the longest and the shortest day of the year, dates of perihelion and aphelion, and corresponding Sun-Earth distances, precise values of obliquity of the ecliptic and eccentricity of the Earth orbit, date of Easter and the Qibla (direction of Mecca).

Times are given in Universal Time.

## Daily ephemeris

Ephemeris	
<b>Daily Data</b>	
Date	2 January 2017 @ 0 h (UT)
Julian Day	2457755.5
Day of the Year	2
Day of the Week	Monday
Julian Century	0.170034223
Equation of Time	3 min 54.4 s (234.43651 s)
Sidereal Time of Greenwich at 0 h UT	6 h 47 min 18 s (6.78824 h)
Right Ascension of the Sun	18 h 51 min 14 s (18.853834 h)
Declination of the Sun	-22° 54' 54" (-22.915039°)
Mean Longitude of the Sun	281° 49' 46" (281.829399°)
True Longitude of the Sun	281° 46' 54" (281.781632°)
Apparent Longitude of the Sun	281° 46' 26" (281.774011°)
Mean Anomaly of the Sun	358° 35' 59" (358.599655°)
True Anomaly of the Sun	358° 48' 46" (358.812715°)
Equation of the Center of the Sun	-0° 02' 52" (-0.047767°)
Distance of Earth to Sun	0.983302986 A.U. (147100032 km)
Hour of Sunrise	7 h 17 min 14 s (UT)
Hour of Passage at Meridian	11 h 40 min 17 s (UT)
Hour of Sunset	16 h 03 min 19 s (UT)
Azimuth at Sunrise/Sunset	-/+56° 08' 06" (-/+56.1349°)
Altitude at Meridian	21° 23' 06" (21.3850°)
Duration of the Day	8 h 46 min 04 s (8.76786 h)
Duration of the Civil Twilight	0 h 34 min 08 s (0.56903 h)
Duration of the Nautical Twilight	1 h 11 min 42 s (1.19510 h)
Duration of the Astronomical Twilight	1 h 47 min 47 s (1.79635 h)
Duration of true night	11 h 38 min 22 s (11.63944 h)
Apparent Diameter of the Sun	32.5308"

Daily ephemeris is calculated for the Reference location and for the date selected in the  [Configuration](#) menu > [Define the ephemeris date...](#)

Data are calculated at 0 h UT. Data provided here are: date, Julian day, day of the year, day of the week, Julian century, equation of time, sidereal time of Greenwich at 0 h UT, position of Sun: right ascension, declination, hour angle, azimuth, altitude, orbital parameters of Sun: ecliptic longitude (mean, true, apparent), anomaly (mean, true), equation of center, distance of the Earth to the Sun, hour of sunrise and sunset, hour of passage at meridian, azimuth at sunrise/sunset, altitude at meridian, duration of day, duration of twilights (civil, nautical, astronomical), apparent diameter of the Sun.

## Instant ephemeris

Ephemeris	
Instant Data	
Date	2 January 2017
Location	AIX-LES-BAINS, FRANCE
Universal Time	17 h 29 min 26 s (17.49056 h)
Civil Hour	18 h 29 min 26 s (18.49056 h)
Solar Hour	17 h 48 min 51 s (17.81417 h)
Daylight Saving Time	No
Julian Day	2457756.22877
Equation of Time	4 min 14.7 s (254.70541 s)
Sidereal Time	0 h 43 min 16.059 s (0.72113 h)
=Nutation in longitude	-6.425663"
=Nutation in obliquity	-8.952240"
Apparent sidereal time	0 h 43 min 15.666 s (0.72102 h)
Right Ascension of the Sun	18 h 54 min 26.5 s (18.9074 h)
Declination of the Sun	-22° 50' 51.0" (-22.8475°)
Distance of Earth to Sun	0.983300059 A.U. (147099594 km)
Hour Angle of the Sun	-18 h 11 min 10.4 s (-18.1862 h)
Azimuth of the Sun (h)	4 h 47 min 02.6 s (4.7841 h)
Azimuth of the Sun (°)	71° 45' 39.0" (71.7608 °)
Altitude of the Sun	-14° 16' 18.0" (-14.2718°)
Zenithal Distance of the Sun	104° 16' 18.0" (104.2718°)

Instant ephemeris can be calculated for a given instant defined in the  **Configuration** menu > **Define the ephemeris date...** or in real time, updated every second (the clock of the PC is used as civil time).

This section provides data valid for the selected date and instant, or recalculated in real time each second. Data provided here are: Universal time, civil time, solar time, Julian day, equation of time, sidereal time, right ascension, declination, distance of the Earth to the Sun, hour angle, azimuth, altitude, and zenithal distance.

## Ephemeris generator

This function generates a text file containing a table of data calculated for each hour or each day. The data contained can be selected, as well as the number of lines to generate.

YYYY MM DD	year, month, day	
hh mm ss	hour, minutes, seconds	
JD	Julian day	in days
EoT	Equation of time	in seconds
st	Sidereal time	in hours
Az	Azimuth of the Sun	in hours
Ht	Altitude of the Sun	in degrees
RA	Right ascension of the Sun	in hours
Dec	Declination of the Sun	in degrees
HA	Hour angle of the Sun	in hours UT
HSe HSw	Time of sunrise and sunset	in hours UT
DD	Duration of the day	in hours
HSS	Meridian transit time	in hours UT

The ephemeris generator is available only in **Shadows Pro**.

## Lunar ephemeris

Ephemeris	
=Données lunaires	
Date	2 January 2017
=Heure de lever de la Lune	9 h 22 min 58 s (UT)
=Azimut de la Lune au lever	-71° 59' 20" (-71.9889°)
=Heure de passage au méridien	14 h 35 min 32 s (UT)
=Hauteur de la Lune au méridien	31° 49' 05" (31.8181°)
=Heure de coucher de la Lune	19 h 48 min 06 s (UT)
=Azimut de la Lune au coucher	+71° 59' 20" (+71.9889°)

=Phases de la Lune	
=Âge de la Lune	4.48
=Nouvelle Lune	29 December @ 6 h 54 min 18 s (UT)
=Premier quartier	5 January @ 19 h 48 min 57 s (UT)
=Pleine Lune	12 January @ 11 h 34 min 37 s (UT)
=Dernier quartier	19 January @ 22 h 15 min 13 s (UT)
=Prochaine nouvelle Lune	28 January @ 0 h 07 min 46 s (UT)

The first table gives the hours of moonrise, moonset, transit, as well as its altitude at transit and its azimuth at the horizon.

The second table gives the age of the Moon for the chosen date as well as the dates of the main phases.

Lunar ephemeris are available only in **Shadows Pro**.

## The solar graph

### The polar solar graph

This graph is available from the [Display menu > Solar graph](#).

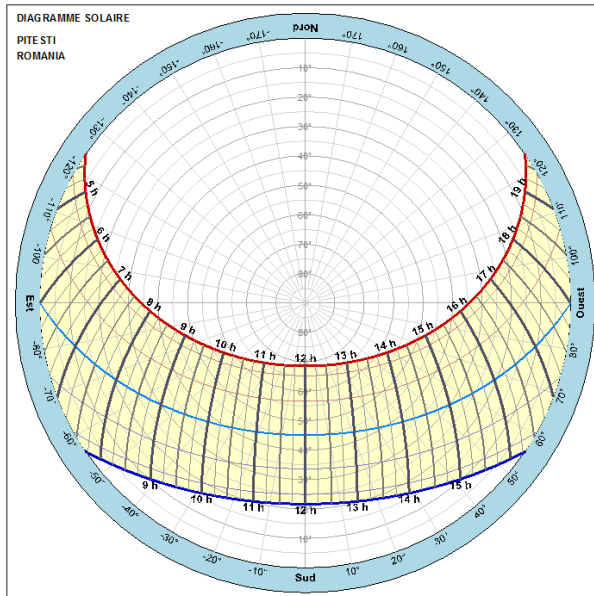

The solar graph represents the horizon circle with scales in altitude up to the Zenith, and on which are drawn the Sun's trajectories at several moments of the year and different moments of the day.

It is possible to superimpose a horizon mask to show obstacles on the horizon by clicking on the



This function is available only in [Shadows Pro](#).

### The horizontal solar graph

This graph is available from the [Display menu > Solar graph](#) then on the  icon. It displays the Sun's altitude as a function of azimuth, during the year. The azimuth 0° corresponds to the direction of the local meridian (direction of south in the northern hemisphere).

This graph is useful for predicting the duration of sunlight on a sundial and moments where it will be in the shadow of an obstacle (building, tree, etc.) and so cannot give time.

This function is available only in [Shadows Pro](#).

### The horizon mask

It is possible to define a horizon mask describing the obstacles on the horizon that may affect the illumination of the sundial. The mask is defined by a series of points (altitude for a given azimuth). An altitude of 0° lays on the horizon, an altitude of 90° is at the zenith. It is possible to draw houses and trees that may cast a shadow on the sundial. The horizon mask is saved in a text file [HorizonMask.txt](#) which is loaded automatically when the dialogue is open, and saved when the dialog is closed. Only one mask can be defined at a time.

## Other graphs and tools

### Time of sunrise and sunset

This graph is available in the **Display** menu > **Solar graph** then by clicking on the  icon.

This graph provides the civil time (watch time) of sunrise, meridian transit and sunset as a function of the date, for a given location. The longitude correction is already included in the graph.

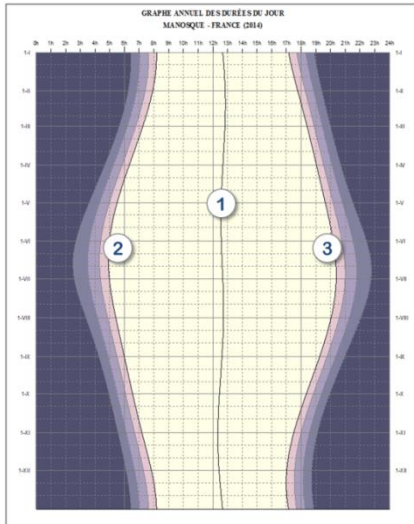

1. Solar noon – meridian transit time.

2. Sunrise

3. Sunset

Colored areas outside the sunrise and sunset curves are twilights, with, from the lighter to the darker: the civil twilight, the nautical twilight and the astronomical twilight.

This graph is calculated for the **Reference location**. The reference location can be changed in the location database.

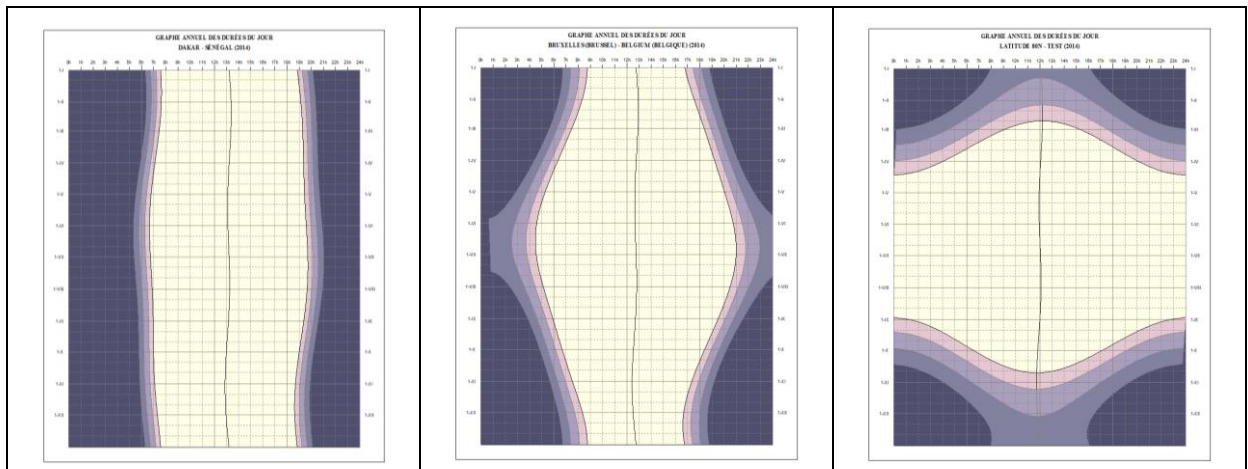

Above: the left graph is calculated for Dakar, Senegal (latitude 14° 40'); it can be noted that the duration of the day is almost the same for the entire year. In the middle, the city of Brussels, Belgium (latitude 50° 50'); the duration of the day is around 8 hours in winter and more than 16 hours in summer. On the right, a location at 80° of latitude where there are periods of continuous night and continuous day.

## Graph of efficiency of a solar panel

This graph is available from the **Display** menu > **Solar graph** and by clicking on the  icon.

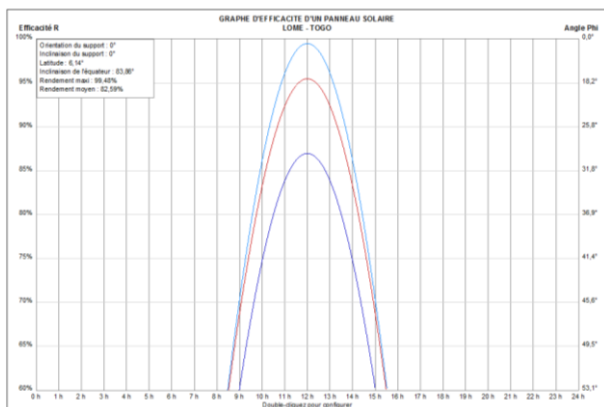

This graph provides the efficiency rate in % for the solstices and equinoxes. The efficiency is maximum when the Sun is facing the panel.

The value on the right axis is the angle of the Sun from the perpendicular direction of the panel.

By double-clicking on the graph or clicking on the  icon, you can configure the orientation and inclination of the panel, and select the location of installation.

Solar panels installed on and parallel to the roof of a house cannot be oriented optimally. This function makes it possible to predict the efficiency of the panel. Note that the value does take into account light absorption due to the weather or the atmosphere (at low altitude).





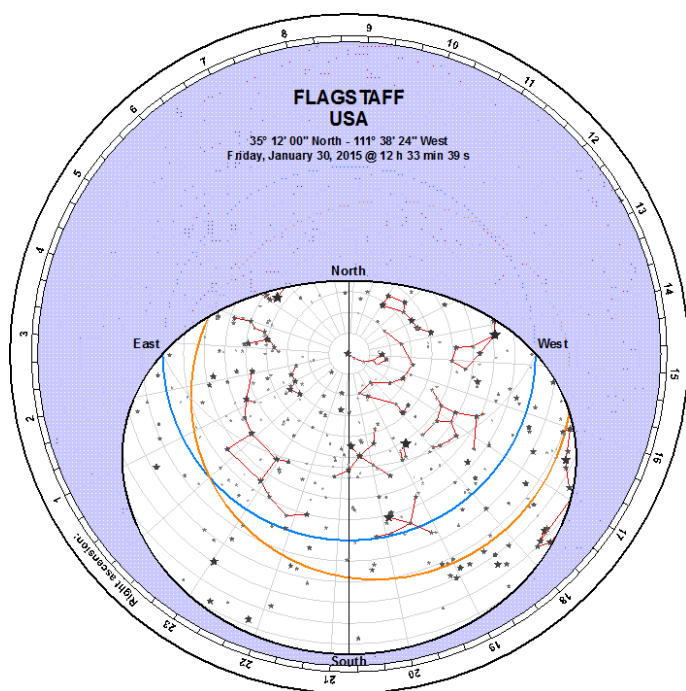



## The mobile sky map

The sky map is available from the **Display** menu > **Solar graph** and by clicking on the  icon.



The map displays selected stars and constellations inside the horizon circle of the selected location, for a given date and time.

Several options are available in the toolbar:

-  : Display tropic circles
-  : Display celestial equator
-  : Display ecliptic circle
-  : Display equatorial scales
-  : Display horizontal scales
-  : Display horizon mask
-  : Change the reference location
-  : Change the date
-  : Display the position of Sun

## The protractor

The protractor is available from the [Display](#) menu > [Drawing tools](#) and by clicking on the  icon.

This protractor is provided to make the drawing of the sundial easier on real material (wood, marble, etc.). Tables of coordinates give Cartesian and polar values and it is sometimes easier to use polar coordinates on large sundials. The accuracy of the drawing can be improved with protractors larger than the ones that can be found in stores.

The default drawing provides a 12 cm radius protractor on an A4 page. Go to [Configuration](#) > [Dimension of the drawing...](#) to set the number of pages on which to draw the protractor. It is then possible to print it directly on an A3 page to have a bigger one.

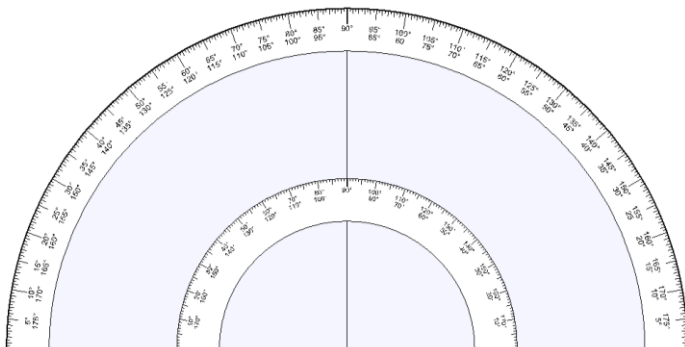



Then paste the page on cardboard and cut around and inside the circle. Sundial drawings can then be made with this protractor and a long ruler.

## The azimuth circle

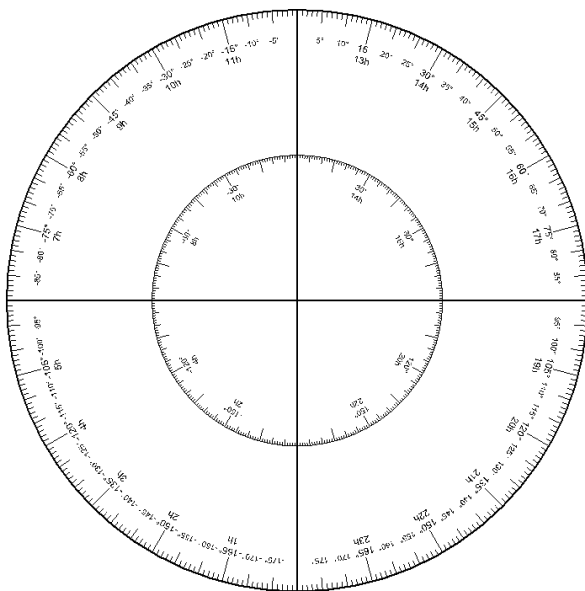
The azimuth circle is available from the [Drawing](#) menu > [Drawing tools](#) and by clicking on the  icon.



This option allows one to draw a big circle graduated in degrees and hours. This circle can be used to measure an azimuth or an hour angle, or as an equatorial or a declination circle.

Its size can be selected in  [Dimension of the drawing...](#) which allows you to choose on how many pages the circle will be drawn. In this case, be sure to draw the printing cutouts, in  [General preferences](#) > [Document](#); it will make it easier to assemble precisely all pages.

## The tangent network

The tangent network is available from the [Affichage](#) menu > [Drawing tools](#) and by clicking on the  icon.

This network is aimed at helping one to measure the declination of a wall. You need to put the network against a wall, the lines vertically (parallel to a plumb line).

A style is installed on the 0° line, perpendicularly to the sheet. By default, the style height is set to 50 mm. By hitting the + or - keys of the keyboard, you can enlarge or reduce the style height by 5 mm.

The method to measure the wall declination is given in the following page Find the declination of a wall.

In order to increase the precision, it is recommended to print the network on several pages. To do so, go to Dimensions of the drawing... and set the number of pages. Used together with a large style, it will allow a better precision. When the distance between two lines is large enough, a dashed line is drawn for each 1/2 degrees.

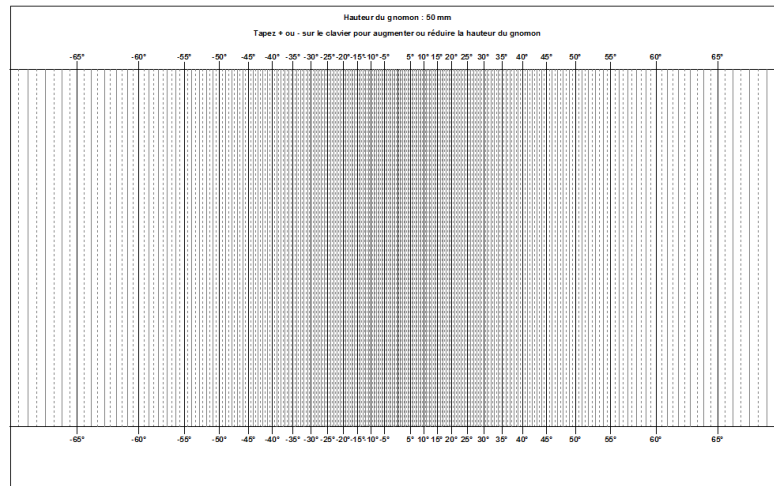

## The compass rose

The compass rose is available from the **Display** menu > **Drawing tools** and by clicking on the  icon.

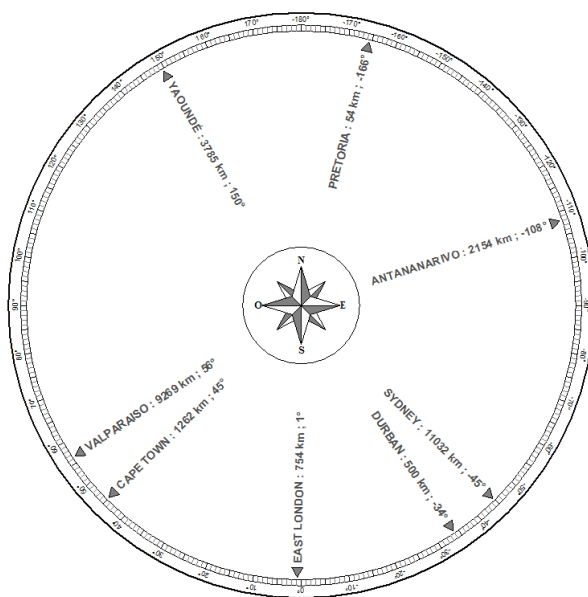

*A compass rose made for Johannesburg (South Africa)*

The compass rose is a disk giving the direction and the distance to the cities or points of interest. It can be seen sometimes in viewing points showing summits around the horizon.

To define points of interest, select  **Configure the compass rose** in the **Configuration** menu. In the dialog box, select the origin location (upper right), then add locations (points of interest) that will be shown on the compass rose.

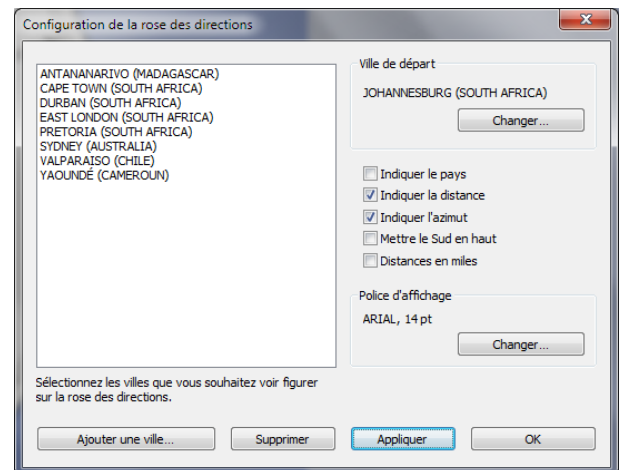

The compass rose is available in **Shadows Expert** and **Shadows Pro**.

## Determination of sundial parameters from a photo

This tool is available from the [Tools](#) menu >  [Determination of sundial parameters from a photo...](#) This tool allows one to find for which latitude a vertical sundial was designed, and with which orientation.

The tool works only for vertical sundials, facing south or any direction within  $\pm 90^\circ$  from the South (or the north in southern hemisphere).

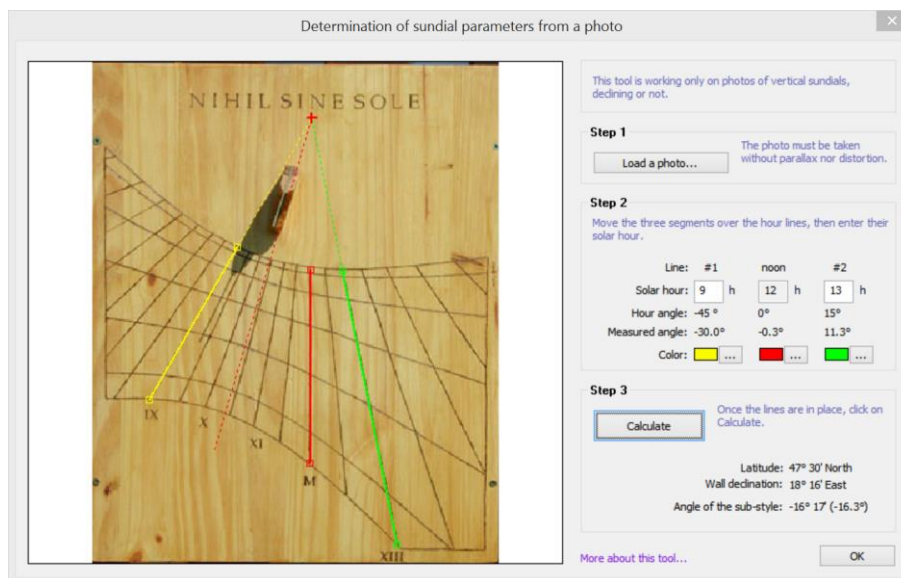

**1. Load an image** – Click on the button [Load a photo](#) and select an image file. Files can be in BMP, JPG or GIF format. For a better precision, the photo must have been taken in front of the sundial, without any parallax (horizontal or vertical), and without optical deformations due to the camera. You can check that the sides of the sundial are parallel to the frame of the photo.

**2. Place the segments on hour lines** – The middle segment must be placed on the solar noon line. Place one line on each side of the noon line. Move the segments by clicking on their handles on each end. Enter the solar time corresponding to each line. They must be integer hours.

### 3. Calculate

The following information is provided:

- The latitude of the sundial;
- The declination of the wall, with respect to the meridian direction (south or north). A negative value means that the wall is east from south (in the northern hemisphere) or east of north (in the southern hemisphere);
- The sub-style angle with respect to the noon line. A negative angle means that the sub-style is on the left of the noon line (in northern hemisphere), and that the sundial is facing east from south. The sub-style line is drawn with a dash line.

With a good photo, the latitude can be estimated with an accuracy of approximately  $1^\circ$ , and the orientation with an accuracy of around  $2^\circ$  to  $3^\circ$ . Errors usually come from the position of segments on the photo.

*Photo: Mickaël Porte*

## PART 5 – EXPLORING FURTHER

### Become a member of a sundial society

If you want to meet other sundial enthusiasts, discuss technology and history, and learn from experienced users, become a member of a sundial society.

#### British Sundial Society (BSS)

c/o The Royal Astronomical Society, Burlington House, Piccadilly, London W1J 0BQ, United Kingdom

[www.sundialsoc.org.uk](http://www.sundialsoc.org.uk)

#### North American Sundial Society (NASS)

c/o Frederick W. Sawyer III, 27 Ninas Way, Hampton Run, Manchester CT 06040-6388, USA

[www.sundials.org](http://www.sundials.org)

#### from other countries

France: [www.commission-cadrans-solaires.fr](http://www.commission-cadrans-solaires.fr)

Italy: [www.gnomonicaitaliana.it](http://www.gnomonicaitaliana.it)

Spain: [www.relojesdesol.info](http://www.relojesdesol.info)









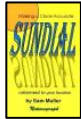

Spain (Catalonia) [www.gnomonica.cat](http://www.gnomonica.cat)

Austria: [www.gnomonica.at](http://www.gnomonica.at)

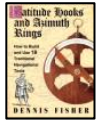
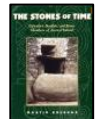

## Bibliography

### Books on sundials

<p><a href="#">The Book Of Sun-Dials Collected By Mrs. Alfred Gatty</a>, by H.K.F. Gatty and E. Lloyd, Kessinger Publishing, ISBN 1162981113, 2010</p>	
<p><a href="#">Monks, Manuscripts and Sundials: The Navicula in Medieval England</a>, by Catherine Egleton, Brill Academic Publishers, ISBN 9004176659, 2010</p>	
<p><a href="#">Sundials: Design, Construction, and Use</a>, by Denis Savoie, Springer Praxis, ISBN 0387098011, 2009. <i>A reference book from one of the best specialists in gnomonics. Easy to read, well explained and illustrated.</i></p>	
<p><a href="#">Sundial</a>, by F. Miller, A. Vandome and J. McBrewster, Alphascript Publishing, ISBN 6130073240, 2009</p>	
<p><a href="#">A Book of Sundial Mottoes</a>, by Alfred H. Hyatt, BiblioBazaar, ISBN 1110384270, 2009</p>	
<p><a href="#">Sundials: Webster's Timeline History, 520 BC-2007</a>, by ICON group international, ISBN 0546908020, 2009</p>	
<p><a href="#">Ye Sundial Booke</a>, by T. Geoffrey and W. Henslow, Read books, ISBN 1408621967, 2008</p>	
<p><a href="#">Sundials</a>, by C. St. J.H. Daniel, Shire, ISBN 074780558X, 2008</p>	
<p><a href="#">Sundials: History, Art, People, Science</a>, by Mark Lennox-Boyd, ISBN 0711224943, 2006</p>	
<p><a href="#">Easy-To-Make Wooden Sundials: Instructions and Plans for Five Projects</a>, Milton Stoneman, Dover Publications, ISBN 0486241416, 2003.</p>	
<p><a href="#">Sundials at Greenwich: a catalogue of the sundials, nocturnals, and horary quadrants in the national maritime museum</a>, Greenwich, by National Maritime Museum &amp; Hester Higton, 2002, ISBN 0198508778</p>	
<p><a href="#">Sundials: An Illustrated History of Portable Dials</a>, by Hester Higton, Philip Wilson Publishers Ltd, ISBN 0856675237, 2002</p>	

<a href="#">Sundials: their construction and use</a> , by R. Newton Mayall & Margaret W. Mayall, Dover publications, 2000, ISBN 048641146X	
<a href="#">Sunclocks: paper sundials to make and use</a> , by Jeffrey V. Trionfante, Jvt publications, 1999, ISBN 1893812510	
<a href="#">Making a Clock-Accurate Sundial</a> , by Sam Muller, Naturegraph Publishers, ISBN 0879612460, 1997	
<a href="#">Sundials: history, theory and practice</a> , by Rene R.J. Rohr, Dover publications, New-York, 1996, ISBN 0486291391	
<a href="#">Latitude hooks and azimuth rings</a> , by Dennis Fisher, Ragged Mountain Press, ISBN 0070211205, 1994	
<a href="#">The Stones of Time: Calendars, Sundials and Stone Chambers of Ancient Ireland</a> , by Martin Brennan, Inner Traditions Bear and Company, ISBN 0892815094, 1994	
<a href="#">A celebration of Cornish sundials</a> , by Carolyn Martin, Truran, ISBN 1850220719, 1994	
<a href="#">Sundials &amp; Time dials</a> , by Gerald Jenkins & Magdalen Bear, Tarquin Publications, Norfolk, England, ISBN 0906212596, 1987	
<a href="#">Anno's sundial</a> , by Mitsumasa Anno, Philomel Books, ISBN 0399213740, 1987	
<a href="#">Sheding a glorious light</a> , Stained Glass Window Sundials, by C. Daniel, 1987	
<a href="#">The art of sundial construction</a> , by Peter Drinkwater, Warwick, UK, ISBN 0946643091, 1985	
<a href="#">The great sundial cutout book</a> , by Robert Adzema, E D Dutton, 1978, ISBN 0801531179	
<a href="#">Greeks and Roman sundials</a> , by Sharon L. Gibbs, Yale Univ. Press, 1976, ISBN 0300018029	
<a href="#">Sundials: their theory and construction</a> , by Albert E. Waugh, Dover books, London, 1973	
<a href="#">Sundials: a simplified approach by means of the equatorial dial</a> , by Frank W. Cousins, Baker Ed., ISBN 0212983555, 1969	
<a href="#">Scratch-dials and medieval church sundials</a> , by T.W. Cole, self published, 1938	
<a href="#">The book of old sundials</a> , by Lancelot Cross, London, Foulis, 1914	

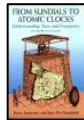

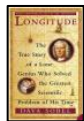
## Books about time

<p><a href="#">Tools of Timekeeping: A Kid's Guide to the History &amp; Science of Telling Time</a>, by Linda Formichelli &amp; W. Eric Martin, Nomad Press, ISBN 0972202676, 2005</p>	
<p><a href="#">From sundials to atomic clocks: understanding time and frequency</a>, by Joanes Jespersen &amp; Jane Fitz-Randolph, Dover publications, 2003, ISBN 0486409139</p>	
<p><a href="#">Time's Pendulum: The Quest to Capture Time - From Sundials to Atomic Clocks</a>, by Jo Ellen Barnett, Perseus Books, ISBN 0306457873, 1998</p>	
<p><a href="#">Longitude: the true story of a lone genius who solved the greatest scientific problem of his time</a>, by Dava Sobel, Harper Perennial, ISBN 0007214227, 2005. <i>A great book about an incredible story!</i></p>	

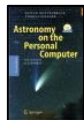
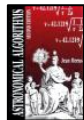
## Books about astronomical calculations

<p><a href="#">Astronomy on the personal computer</a>, by Richard M. West, Springer, ISBN 3540672214, 2000</p>	
<p><a href="#">Astronomical algorithms</a>, by Jean Meeus, Willmann-Bell, Richmond, ISBN 0943396611, 1998 <i>The best book ever published on astronomical equations and algorithms!</i></p>	

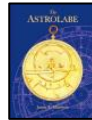
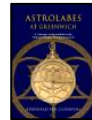
## Books on astrolabes

<p><a href="#">A treatise on the astrolabe</a>, by Walter William Skeat et Geoffrey Chaucer, Ed. BiblioBazaar, ISBN 1-1036-3101-2</p>	
<p><a href="#">The astrolabe</a>, by James E. Morrison, Ed. Janus, ISBN 0-9393-2030-4. <i>An excellent book that makes a synthesis of what was written on astrolabes up to now.</i></p>	
<p><a href="#">Astrolabes at Greenwich: A Catalogue of the Astrolabes in the National Maritime Museum</a>, by Koenraad van Cleempoel, Oxford, 2006, ISBN 0-1985-3069-2</p>	
<p><a href="#">Al-Farghani, On the astrolabe</a>, by Richard Lorsch, Franz Steiner Verlag, ISBN 3-515-08713-3</p>	
<p><a href="#">L'astrolabe, histoire, théorie et pratique</a>, de Raymond d'Hollander, Ed. Institut Océanographique, Paris, ISBN 2-9035-8119-3, 1999. <i>Reference book (in French) for the construction and the use of various types of astrolabes. Describes both calculations and geometrical constructions.</i></p>	

## Glossary of technical terms

**Abscissa** – Name given to the horizontal component of a Cartesian coordinate. The abscissa is usually written  $x$ .

**Alidade** – Ruler equipped with pointers, that can be rotated to measure angles. Alidades are usually found at the back of astrolabes.

**Almucantar** – Arc drawn on an astrolabe, to mark the altitude of a star. Sometimes called *Almucantar*.

**Altitude** – Angle measured vertically from the horizon up (or down) to the celestial object, yielding values between  $-90^\circ$  and  $90^\circ$ . The altitude is part of the horizontal coordinates system (with the azimuth). At sunrise or sunset, the altitude of the Sun is  $0^\circ$ .

**Analemma** – Name given to the figure-8 -shaped curve drawn sometimes at the position of an hour line (usually the noon line).

**Analemmatic** – Used to qualify a sundial of elliptical shape for which the style must be moved (on a line) to a position depending on the date. Analemmatic sundials are usually big and drawn on the ground so a person's body is used as a style.

**Anomalistic year** – Time between two consecutive transits of the Earth at its perihelion; it equals 365 days 6 h 13 m 53 s.

**Arcdegree** – Unit used to measure angles. It corresponds to  $1/360$  of a circumference. A degree contains 60 arcminutes of 60 arcseconds each.

**Arcminute** – Unit used for angle measurement. There are sixty arcminutes in a degree. One arcminute contains sixty arcseconds.

**Arcsecond** – Unit used for angle measurement. There are sixty arcseconds in an arcminute.

**Armillary sphere** – Sphere reproducing the Earth, inclined parallel to the polar axis. Its equator is graduated to give the hours by the shadow cast by the pole axis of the sphere. It is a kind of equatorial sundial.

**Atmospheric Refraction** – Deviation of light rays due to variations in atmosphere's ability to bend light. The effect is often most visible when the celestial body is close to the horizon. For example, the image of the Sun can be visible above the horizon while the Sun is below. The effect is usually around 36 arcseconds on the horizon.

**Azimuth** – Angle between a vertical plane passing through a given point in the sky, and the meridian plane of the location. The azimuth is counted positively from the south to the west.

**Babylonian hours** – The Babylonian hours were counted from the sunrise (with constant duration for an hour, contrary to the temporary hours). Babylonian hours were useful to know the time since the sunrise. Those hours were used by the Chaldeans, the Egyptians, the Persians, the Syrians and the Greeks.

**Brachiolus** – Articulated arm used on universal astrolabes (Sphaera Arzachelis) to point a particular coordinate.

**Butterfield** – Type of portable horizontal sundial, equipped with a foldable style that can be adjusted in latitude. It has several sets of hour lines, in concentric bands to allow the reading of time at several latitudes. These sundials are often made in precious material (such as silver).

**Celestial equator** – Projection of the Earth's equator on the celestial sphere.

**Circle** (great circle, small circle) – A great circle is a circle on a sphere whose diameter is the same as the diameter of the sphere. Meridians and the equator are great circles of the Earth. A small circle is a circle on the sphere whose diameter is smaller than the diameter of the sphere. A parallel at a latitude greater than  $0^\circ$  is a small circle.

**Civil time** – Mean time of the reference meridian, shifted if needed by one hour if the daylight saving time is used. Civil time is the clock time.

**Colatitude** – Is the complementary angle of the latitude, taken from the pole. The co-latitude is (in degrees) equal to  $90^\circ - \text{latitude}$ .

**Declination** – Angular distance of a point on the celestial sphere to the equatorial plane, with the convention of positive (0° to 90°) toward the north, negative toward the south.

**Declination arc** – Trajectory of the shadow's endpoint on the sundial, during the day. This curve is usually an hyperbola, except for the equinox where it is a straight line.

**Declination lines** – Lines indicating the date using the end of the shadow of the style. The lines are generally drawn for every Zodiac change (corresponding to the declinations 0°, +/-11°29', +/-20°20' and +/- 23°26').

**Diptych sundial** – Sundial formed of two articulated parts, one horizontal, one vertical, with a common style realized with a thread. It is a portable sundial that can be kept in a pocket.

**Ecliptic** – [1] Plane of the Earth's orbit around the sun. [2] Large circle on the celestial sphere, where the Sun moves in its apparent motion.

**Ecliptic longitude** – Angle counted on the Earth orbit between the position of Earth and the Vernal point. It is separated in sectors of 30° that define astronomical zodiac signs.

**Equation of time** – The difference between solar time and mean time. This equation varies during the year and its value can reach ±16 minutes.

**Equinox** – One of the two days in a year, when the sun is crossing the celestial equator. At the equinoxes, the day and the night have the same duration.

**Equatorial coordinates** – Right ascension and declination of a star. Coordinate system anchored on the ecliptic. The origin of the right ascension is the vernal point; it is counted from 0 to 24 hours anticlockwise. The declination is counted from 0 to +/- 90° around the equator.

**Geographic north** – Direction included in the meridian plane, pointing towards the geographic north celestial pole. It's the direction used in gnomonics (not the magnetic north).

**Gnomon** – Primitive sundial made of a simple rod whose shadow is cast on the ground. Today, this term is used to name the style planted perpendicularly to the sundial table.

**Gnomonics** – The science of sundials.

**Greenwich** – English city located near London.

**Greenwich meridian** – Meridian crossing the Greenwich observatory, used as the reference meridian to measure longitudes on Earth.

**Greenwich Mean Time** (GMT) – Time equals the civil time of Greenwich shifted by 12 hours. This time should not be used to call the standard time of Great Britain, which has been replaced by the Universal Time.

**Hemisphere** – Half of a sphere, separated by an equator plane. On Earth, there is the northern (or boreal) hemisphere and the southern (or austral) hemisphere.

**Horizontal coordinates** – Azimuth and height of a star. This coordinate system is local to the observer. The azimuth is counted from 0 to 180° starting on the local meridian. The altitude is counted from 0 to 90° above the horizon.

**Hour Angle** – Angle between the plane of the great circle through an object and the meridian of the location. It is calculated in a retrograde sense, sometimes in degrees, but more often in hours, from 0 to 24 hours, or from -12 to +12 hours. The hour angle (H) and the right ascension ( $\alpha$ ) are related to each other and to the hour angle of the Vernal Equinox (T) by the following formula:  $T = \alpha + H$ .

**Hour coordinates** – Hour angle and declination. This system is intermediate between the horizontal system and the equatorial system (using it simplifies the coordinate conversion). The origin of the hour angle is the local meridian.

**Hour line** – The lines that allow you to read the hour using the shadow of the style.

**Hypotenuse** – Longest side of a right triangle. The side opposite the right-angle.

**Italic hours** – The italic hours were counted from the sunset of the previous day. Those hours were in use until the end of the 18th century in Italy.

**Latitude** – Angle formed, in a given place, by the local vertical and the equatorial plane. The latitude is counted from the Earth equator, positively towards the north (from 0° to 90°), and negatively towards the south.

**Leap year** – Year that contains 366 days, obtained by the insertion of an additional day on February 29th, every four years. This procedure provides a mean year duration of 365.25 days which is close to the anomalistic year duration. Years for which the millennial value is dividable by 4 are leap years, except those which are not multiples of 400! For example: 1968, 1996, 2000 are leap years but 1900 and 2003 are not.

**Longitude** – Angle formed by the local meridian and the Greenwich meridian, counted from 0° to 180°, starting at Greenwich, positively towards the West.

**Magnetic north** – Direction given by the compass. It varies from one place to another due to variations in the local magnetic field of the Earth. This direction cannot be used in gnomonics to obtain accurate results.

**Mean time** – It's the solar time corrected by the equation of time. From mean time, you can add the longitude correction to obtain the civil time.

**Meridian** – [1] Set of all locations having the same longitude on Earth. [2] Plane defined by the local vertical line (plumb line) and the axis of rotation of the Earth. (meridian plane). [3] Half circle of the celestial sphere passing through the pole and the local zenith.

**Motto** – Phrase written on sundials, expressing philosophical ideas, usually about the passing of time and the condition of humans. Mottoes are historically in Latin but can be in any language or dialect.

**Nautical twilight** – Instant when Sun reaches 12° below the horizon, and when it becomes difficult to distinguish the horizon line at sea.

**Obliquity of the ecliptic** – Angle between the Earth's rotation axis and the Earth's orbit rotation axis. Its value is 23° 26'.

**Ordinate** – Name given to the vertical component of a Cartesian coordinate. It is often written  $y$ .

**Polar style** – Style that points towards the celestial pole. It is represented by the hypotenuse in a triangular style. The hour lines converge at the foot of the polar style which is labeled point B, in this program. For some sundials, this point is projected far from the foot of the perpendicular style.

**Radian** – Unit used in the angle measurement. There are  $2\pi$  radians in the circumference of a circle. One radian equals  $180/\pi$  degrees.

**Revolutionary time** – Decimal hour containing 100 minutes of 100 seconds. A day contains 10 revolutionary hours. This measure of time was established in 1790 by the French revolutionary council, but has never really been used. It was soon made obsolete.

**Right ascension** – Angle formed by the plane passing through a given point of the celestial equator and the vernal point. It is counted from 0° to 360° or more likely in hours from 0 h to 24 h.

**Sidereal Time** – Hour angle of the Vernal Equinox (T). It is used to define the relative position of the equatorial and hour coordinates.

**Solstice** – One of the two times in the year when the sun is farthest away from the equator. In the northern hemisphere, the summer solstice is on June 21st or 22nd, the winter solstice is on December 21st or 22nd. In the southern hemisphere, it is the opposite.

**Solstice arc** – Declination arc drawn on the solstices. The solstice arcs limit the shadow's extension on the dial.

**Stereographic projection** – Projection of the surface of a sphere onto a plane, seen from a particular point. It is used on a planispheric astrolabe to project the celestial sphere onto the equatorial plane, seen from the South pole.

**Style** – A rod inserted in the table of the dial. Its shadow gives the hour. The style (polar style) is parallel to the polar axis of the Earth.

**Sub-style line** – Line joining the points A and B (in the drawing), between the attach points of the polar style and the perpendicular style.

**Sundial** – Surface with graduations for the hours during the day, on which the shadow of a style is projected by the sun to indicate the hour.

**Sundial declination** – Angle measured between the normal of a wall and the local meridian plane. It is used for example on a vertical declining sundial. The declination is counted positive towards the west, from the south.

**Temporary hours** – Antique hours counting 12 hours between sunrise and sunset. The duration of one hour counted in this system is varying between 40 and 80 minutes throughout the year. These hours are sometimes called Planetary hours.

**Time Zone** – Strip of 15° of longitude stretching from the north pole to the south pole, which allows the globe to be split into 24 segments. Each zone is centered on a meridian at a multiple of 15°. The meridian of origin is that of Greenwich, which defines Universal Time. This zone occupies the longitudes +7.5° to -7.5°. Each country uses, in principle, the hour of the nearest zone in longitude, but this is not the case in Europe where most countries (including France) have adopted the zone UT + 1h. Each time zone is one hour apart. However, some countries have adopted an offset that is not an exact hour, like the center of Australia which is at UT + 9h 30m or Nepal, at UT + 5h 45m.

**Tropic** – Each of the two parallels at latitude 23°27' N and S where the sun reaches the zenith at a solstice. They define a band where the sun can pass the zenith and be in the north direction (northern hemisphere) or in the south direction (southern hemisphere). The northern Tropic is called the Tropic of Cancer and the southern tropic is called Tropic of Capricorn.

**Universal Time** – Universal Time (UT): Standard Time of Greenwich.

**Vernal point** – Intersection between the ecliptic and the celestial equator. The vernal point corresponds to the direction of the Sun when its declination crosses 0° upward (it is then the beginning of spring). The vernal point is noted  $\gamma$ .

**Zenith** – Point of the celestial sphere situated exactly above the local vertical ascending direction.

**Zenithal distance** – Complementary angle of the altitude, equal to 90°-altitude. The zenithal distance is counted from the zenith point above the observer.

**Zodiac** – A set of celestial constellations located on the ecliptic, where the sun moves in its apparent motion. This band is divided into twelve constellations (the astronomers include a thirteenth Zodiac constellation). The sun moves from one constellation of the Zodiac to another, when its declination reaches certain values (0°, ±11°29', ±20°20' and ±23°27')

**Zodiac arc** – Declination arc drawn for a date corresponding to a Zodiac sign change, which is around the 21<sup>st</sup> of each month. There are seven Zodiac signs, among which one is for the equinox, two for the solstices.

## Frequently Asked Questions

### Is there a risk in paying on Internet with Paypal?

Paypal is the world's biggest secure web site for online payment, with hundreds of millions of user accounts. The site offers secure payments and support several currencies. There is no risk in providing your credit card number, because the transaction is encrypted between your PC and the server (as shown by the small padlock on the bottom right of the window). You may also pay by direct transfer if you have a Paypal account. Using Paypal is the most secure and fastest way to get your [Shadows Expert](#) or [Shadows Pro](#) license.

### I cannot pay with a credit card; Can I pay with another payment solution?

You can send cash money (only Euros) by regular mail, or you can use Western Union services.

Read more about payment solutions: [www.shadowspro.com/license](http://www.shadowspro.com/license)

### I want to buy Shadows Pro for my company; can I receive an invoice?

Yes, an invoice will be sent on demand.

### How is Shadows delivered?

The program can be downloaded freely on [Download](#) page ([www.shadowspro.com/download](http://www.shadowspro.com/download)). When you buy a [Shadows Expert](#) or [Shadows Pro](#) license, you receive by e-mail a license file and an activation code that will activate the advanced functions of the program. See the installation procedure in the user manual. There is no delivery by regular mail. The complete process is done using Internet, in order to reduce risks and costs of international shipping.

### Can I obtain Shadows on a physical support?

You can get the program and the license on USB key by ordering [Shadows Pro](#) Box version. You will receive the installation program, you license and a copy of the full web site [www.shadowspro.com](http://www.shadowspro.com).

### I ordered my license several days ago but I did not receive anything yet; why?

The license is sent by e-mail, if you didn't receive it, it may be caused by one of the following reasons:

- your e-mail address was perhaps erroneous => check your payment receipt sent by Paypal
- the message was considered as a spam => check in your spam folder
- your mailbox was full and has rejected the message
- your e-mail address was rejected => provide another address if possible
- the author is sometimes unable to access the Internet during few days

Do not hesitate to contact the author to ask again for the license message.

### Can I install Shadows on MacOS or Linux?

Shadows is developed for the [Windows](#) platform. However, some emulator programs allow Windows programs to run under other operating systems such as MacOS or Linux. Several Shadows users are using this solution, but no guarantee is provided by the author that it will work. Some users reported that they use Shadows under MacOS using the program Wine.

### Can Shadows be used under Windows XP?

Shadows is primarily developed for the latest Windows platforms such as Windows 10, Windows 8.x, Windows 7 or Windows Vista. It is not compatible anymore with Windows XP or older versions.

### During installation, an error message says that this application is not for this Windows version. Why?

Shadows is now a 64-bit application that requires a 64-bit version of Windows. If you have a 32-bit version of Windows, you can still download the 32-bit version of Shadows for a while:

[www.shadowspro.com/download/shadows32bits.exe](http://www.shadowspro.com/download/shadows32bits.exe)

### **How to install the license?**

Just follow the instructions in the section [Installation of the Shadows license file](#) in this user manual.

### **I have installed the license file but Shadows says it is corrupted; what can I do?**

The file has probably been damaged during the transfer or when it was saved. Contact the author to send the message again.

### **I have installed the license file but it is not recognized by Shadows; what can I do?**

The license file must be named [shadows.license.txt](#) and must be saved in the folder [Shadows Data](#) located in [Documents](#). If another name is used, it won't be recognized. Especially, check that the file does not have the extension twice (shadows.license.txt.txt) by enabling the viewing of file extensions in Windows.

### **I installed the new version but I can't access to the advanced functions; why?**

The license file is normally copied automatically in the new folder. In case it failed, just follow the instructions in the installation guide.

### **I installed my license file but some functions are still locked with a red key!**

Shadows exists in three levels: [Shadows](#), is a freeware and does not need any license file, [Shadows Expert](#) and [Shadows Pro](#), each requiring a license file. The [Shadows Expert](#) license will unlock functions marked with a yellow key, you will still see the red keys in this case. The [Shadows Pro](#) license will unlock the complete program.

### **I installed Shadows and it says that my license was found but asks me to associate the license. Why?**

Shadows requires the license to be associated with the PC on which Shadows is used. To do so, click on the button [Associate the license](#) in the dialog displayed at launch. During the operation, Shadows will communicate with a distant server. Once the license is associated, you do not need to be connected to the Internet anymore.

### **I do not have an Internet connection on my PC. How can I associate the license?**

Click on the button [Associate the license](#) in the dialog box displayed at launch. You will get an error but a file is created in the folder [Documents/Shadows Data/Association](#). Send this file to the author [fblateyron@shadowspro.com](mailto:fblateyron@shadowspro.com) and you will receive in return your associated license.

### **I got a communication error during the association process. What can I do?**

In case of a communication error during the association, look for a text file in the folder [Documents/Shadows Data/Association](#). Send this file to the author [fblateyron@shadowspro.com](mailto:fblateyron@shadowspro.com) and you will receive in return your associated license.

### **Shadows tells me that a new version is available on line; can I download it?**

Of course! No matter if use the freeware version of Shadows or one of the advanced versions like [Shadows Expert](#) or [Shadows Pro](#), you can freely download any new version. New versions bring improvements and new features. It is always recommended to upgrade to the latest version.

### **I use an old version, can I upgrade directly to the latest version ?**

You can upgrade from any version to the latest version, freely. The latest version always includes all the new features and improvements introduced by intermediate versions.

### **My computer crashed and I lost the Shadows license file; what can I do to get it back?**

Send an Email to the author and ask to have the license file resent.

### **I will need to change my PC; what do I need to do to transfer the Shadows Pro license?**

It is now possible to transfer the license as follows:

- On the previous PC, click on the [Help](#) menu and [Remove the license association](#)
- Save the file [shadows.license.txt](#) located in [My Documents/Shadows Data](#)
- On the new PC, install the latest version of Shadows
- Copy the saved license in [Shadows Data](#) and start Shadows, and click on [Associate the license](#)

### **My firewall program has detected that Shadows tries to connect to Internet! Does it contain a virus or a spyware?**

Shadows periodically checks if a new version is available on the web site [www.shadowspro.com](http://www.shadowspro.com). To do so, the program detects if an Internet connection is active and consults a file containing the available version. So it is normal that Shadows establishes a connection. There is no risk for your computer, Shadows does not contain any virus and does not send personal information on the Internet. Normally the verification is a transparent mechanism for the user, even if no connection is there. But if your computer is protected by a firewall, the connection will be detected and you will be notified. It is therefore recommended to configure your firewall and authorize Shadows to use Internet.

You can also disable the automatic mechanism in the  [General preferences](#).

### How to translate the program?

Shadows is developed in French and English by the author. Other translations have been made by users. Translations of the user interface can be modified by users themselves and new translations can be proposed to the author.

A complete translation includes:

- strings from the user interface,
- help files or from version 4, the user manual.

It is possible to use the program in one language and use another language for the help.

### How to translate the user interface?

Strings are stored in a text file called `shadows.language.txt`. This file can be loaded in Excel, for example. The first four columns are keywords used by the program to find the right string. Then, there is one column of text by language.

To modify the translation file, go to the menu **Help > Translations > Open the translation table**. The file is opened with Excel. Once modifications are made, save it (it must be saved in **Unicode Text** file format under the name `shadows.language.txt` in the folder **My Documents/Shadows Data**). Then you can check the results in Shadows by selecting **Reload the translation file** in the same menu.

It is possible to add a new language that is not yet available in the program. After the first header lines, one can find two lines used to declare language names. The first one contains the English name of the language (*i.e.*, German). The second line contains the local name of the language (*i.e.*, Deutsch).

If a particular string is not translated, the program will use its English or French translation instead, depending on the language preference.

The two columns containing French and English translations must not be removed or reversed. Other languages may be declared in any order.

**Advice to translators:** you can load the file into Excel, write the translation in the right column (or modify an existing one) and you can read the existing translations on the same line to better understand the meaning. It is important not to modify or remove the symbols used sometimes in a sentence (such as `\n`, `%d`, `%s...`). Some lines also do not need translation as they are neutral (the same in all languages). They are marked with the keyword **SKIP** in the first column. Then, when finished, just save the file and test it directly in the Shadows program. Once fixed or completed, you can send the file to the author in order to include it in the installation package for distribution to everybody.

### How to translate the user manual

A new user manual in PDF format now replaces the previous HTML online help. For the moment, the user manual is available in French and English. If you want to translate the user manual, contact the author to get the Word document and modify it directly.

### Add your own mottoes

Mottoes installed with the program are stored in a text file named `mottoes.txt`.

The first lines of the file are comments, and begin by `(;)`.

Each motto is written on a line with some keywords inside brackets `<` and `>`:

```
<LANG:English> I tell only sunny hours. <COMMENT:this is a comment>
```

The keyword `<LANG:>` specifies the language of the motto. The name of the language will be taken into account 'as is' and *english* and *anglais* will be considered as two different languages.

An optional comment can be added to the motto with the keyword `<COMMENT:>`. It may be used to provide a translation or indicate the reference of the source. This comment is not displayed on the sundial but it will be visible in the dialog box.

Users adding mottoes are invited to send them to the author so that other users can also enjoy them.

## Add new locations in the database

The location database is saved into one or two text file(s) organized in a particular manner. Shadows comes with a predefined database stored in the file `shadows.database.txt` in the installation folder. When you add new locations, they are saved into the file `shadows.userdatabase.txt` in order to avoid overwriting new locations when a software upgrade is performed. This file is saved in `My Documents/Shadows Data`.

If you have entered new locations, you can send your file `shadows.userdatabase.txt` to the author and allow all users to use these locations.

It is possible to edit the file to fix or complete some records but you should be very careful when doing so. You should backup the original file before any change. If the file has been changed incorrectly, it could corrupt the whole program.

File Format:

```
$VERSION 7
$NBRECORDS 2755
NEW$ORLEANS LA USA 29.950000 90.066667 -6 1
NEW-YORK NY USA 40.716667 74.066667 -5 1
OKLAHOMA$CITY OK USA 35.466667 97.500000 -6 1
FIRENZE ? ITALY$(ITALIA) 43.766667 -11.250000 1 1
FOGGIA ? ITALY$(ITALIA) 41.450000 -15.566667 1 1
FOLIGNO ? ITALY$(ITALIA) 42.950000 -12.700000 1 1
GELA ? ITALY$(ITALIA) 37.066667 -14.250000 1 1...
$END
```

Reserved keywords start with the character `$`. Lines with keywords should not be modified.

`$VERSION` provides a backward compatibility in case of evolution of the file format.

`$NBRECORDS` provides the number of records in the file. This value is used as a check. If you add some records manually, do not forget to update this value.

`$END` should be at the end of the file.

Each record is defined with several fields separated by a "tabulation" character. The name of the city and of the country should not contain any space; therefore space characters are replaced by `$`:

```
GREENWICH$OBSERVATORY ? ENGLAND$(UK) 51.466667 0.000000 0 1
SAN$MIGUEL$DE$TUCUMA ? ARGENTINA -26.816667 65.216667 -3 1
```

The first field is the name of the city (or location).

The second field in the zone (district, state, region...), or contains the character `?` if not used.

The third field is the country.

Coordinates are given after the country name:

```
SYDNEY ? AUSTRALIA -33.866667 -151.216667 10 1
```

In the above example, the latitude is 33° 52' South (-33.866667° in decimal), and the longitude is 151° 13' East (-151.216667° in decimal), and the time zone is UT+10h. The minus sign "-" in the longitude indicates a place located East of Greenwich meridian; and in the latitude it indicates a southern hemisphere place. The time zone may be positive or negative, and be integer or decimal:

```
MARACAIBO ? VENEZUELA 10.666667 71.616667 -4 1
RAIPUR ? INDIA 21.233333 -81.633333 5.5 1
KATHMANDU ? NEPAL 27.716667 -85.316667 5.75 1
```

After the time zone, a number indicates if the location is standard (1) or has been created by the user (0).

## Edit / Modify a location

This dialog allows you to enter a new location or to modify an existing one. Names are converted into capital letters.

The country will be used to sort the locations. If it is a new country, it will be added in the list of countries. You need to spell the country precisely and always the same way (BELGIQUE and BELGIUM will be considered as two different countries).

The field **Zone** allows you to enter a district, a state or a region. For example French districts are labelled by their number (Paris is 75); American states are denoted by their two-letter abbreviations (CA for California).

Latitude and longitude are entered in two parts: degrees and arc-minutes. Do not enter signs but use the radio buttons to indicate the direction (east or west, north or south).

Note: if you know the latitude in decimal form (ex: 47.267°), you need to calculate the amount of arc-minutes for the decimal part. To do so, multiply the decimal part by 60 and keep the integer part:  $0.267 \times 60 = 16.02'$ . So 47.267° will be entered as 47° 16'. Arc-seconds can be neglected ( $0.02' = 1.2''$ )

The Time Zone can be selected in the list. UT means Universal Time (*i.e.*, the time of Greenwich). UT + 3 h means that the location has a time shift of three hours from Greenwich (and it is east of Greenwich). The additional shifted due to the daylight saving time is not taken into account here. The longitude correction between the location and the chosen meridian is given below. In general this correction should not exceed +/- 2 hours.

In France and the occidental Europe, except Great Britain and Portugal, the standard meridian is UT + 1 h.

### Import a location from Google Maps

**Google Maps** is widely used tool that provides free map of any place in the world. It can be used to find your location and to insert the coordinates of this place into Shadows by copy-paste.

To import a Google Maps place into Shadows: center the place on the map in Google Maps, then click on the link Obtain the URL of this page. Then copy the address line of your Web browser and open in Shadows the dialogue of a new location, then click on the button Paste an URL in the Google Maps frame. The latitude and longitude of the place are automatically recognized. You will need to enter the name, country and time zone.

Google Maps can be reached from [maps.google.com](https://maps.google.com)

### Import a location from Google Earth

**Google Earth** is a very accurate tool for the visualization of the Earth surface. It allows the user to save the geographical coordinates of a viewed place on screen. Shadows now includes an interface with Google Earth, in order to visualize locations of the database and import coordinates from Google Earth.

- Defining a place in Google Earth: the compatible locations with Shadows are the **placemark** represented by a pin or square icon.
- Saving a location file in Google Earth: click on a placemark with the right button of the mouse and select Save As.... Give a name to the file and select type **KML** in the type list (do not save in KMZ).
- Importing a file from Google Earth to Shadows: once the KML file is created, click on the button Import a file in the New location dialog box of Shadows then select the file.
- Copying a place from Google Earth into the clipboard: click on a placemark with the right button of the mouse and select Copy.
- Pasting a Google Earth place into Shadows: click on the button Paste a location in the New location dialog box of Shadows.

Captured information: the location name and the country (if it exists) as well as its coordinates (latitude and longitude) are captured. You will have to enter the Time Zone manually and, in some cases, the country.

**Google Earth** can be downloaded from [earth.google.com](https://earth.google.com)

## Troubleshooting the program

If you encounter any problem with the program, please follow this procedure:

- Go to the [Help](#) menu >  [About Shadows...](#) and note the complete version number
- Check on [www.shadowspro.com](http://www.shadowspro.com) that you have the latest version (the problem may already been fixed)
- If not, download and install the latest version
- If the problem still occurs after the update, check in the [Frequently Asked Questions](#) if a similar problem has been reported
- Ultimately, contact the author and describe your problem as precisely as possible.

Send also the trace file that you can get from the [Help](#) menu > [Troubleshooting](#) >  [Display the trace file](#)

If you have detected a genuine problem, the author will fix it in short notice and will publish a new version. Please note that the support does not apply if your question relates to unsupported platforms such as older versions of Windows or virtual machines running on other operating systems.

## Shadows End User License Agreement

(c) copyright 1997-2019 by François Blateyron, all rights reserved.

Web Site: [www.shadowspro.com](http://www.shadowspro.com) E-mail: [info@shadowspro.com](mailto:info@shadowspro.com)

**Please read this file carefully. Thank you.**

This End-User License Agreement is a legal agreement between you (an individual, an association or an organization) and the author of Shadows (François Blateyron). By installing and using the Shadows, you fully accept the terms of this agreement.

**If you do not agree, you must not install Shadows and delete it from your computer.**

### Freeware version

Shadows, the standard level of this product, is a freeware program. The freeware version requires the user to subscribe to the mailing list.

### Shareware version

You may acquire a license for Shadows Expert or Shadows Pro by paying a license fee. These levels offer advanced features that are not available in the standard level. Please refer to the documentation for information on how to buy these licenses and see the list of features for each level.

### Updates

You may update your version free of charge at any time and without time limitation, to the latest version 4.x, by downloading it from the Shadows Web site ([www.shadowspro.com/download](http://www.shadowspro.com/download)).

### Grant of license

This agreement grants you a non-exclusive right to install and use Shadows on your own computer. The Shadows Expert license can be associated to only one computer. The Shadows Pro license can be associated to up to two of your computers. Products created using Shadows can be transferred or sold without authorization of the author. This includes drawings, tables of results, real sundials you built using the program data, etc. You can use Shadows, Shadows Expert or Shadows Pro for your personal needs or in the context of a commercial activity.

### Distribution

You may transfer or distribute freely Shadows in its original form including the installation program, documentation files and all other files, except your personal license (Expert or Pro).

**It is strictly forbidden to sell Shadows without written permission of the author.**

It is possible to include Shadows in a collection of programs distributed free of charge. However requiring a fee specifically for Shadows is prohibited.

## Individual license file

When using Shadows Expert or Shadows Pro, a license file is sent to you in order to unlock the advanced features of your level. This file is strictly personal and must not be transferred to anybody else. Copying and distributing your license file to someone else is an infringement of copyright laws. The license must be associated to the user's PC. A Shadows Expert license can be associated with only one PC. A Shadows Pro license can be associated with two of your own PCs.

## Personal Data

Users who order a license have to provide their name, address and E-mail. These data are necessary for a correct handling of licenses and are used solely for that purpose. No personal data is shared or sold to anyone.

## Subscription to the Shadows information letter

Users can subscribe on the Shadows web site to a free information letter about Shadows. Around two or three letters are sent every year. Users who purchase a license of Shadows Expert or Shadows Pro accept to be added to the mailing list to receive this information letter. Users can unsubscribe at any time from the mailing list on the MailChimp web site, or by clicking on a link at the end of the information letter.

## Copyright

Shadows is protected by copyright laws and international treaties on intellectual property. The distribution of Shadows, either the freeware or the shareware versions, does not imply any transfer of intellectual property to the user. Components accompanying Shadows shall not be used separately. This includes (but is not limited to) executable code, source code, images, pictures, texts, help files and other documentation, HTML or JavaScript code, icons which are all copyrighted by the author.

Teachers and coordinators may use the software, its creations and its documentation for educational or leisure purposes, privately in a classroom or with a small group of persons.

For any public use of the above material, the publication shall contain the following mention: **“Shadows software, © François Blateyron, [www.shadowspro.com](http://www.shadowspro.com)”** and in the case of publication on a web site, it shall contain a hyperlink to [www.shadowspro.com](http://www.shadowspro.com).

Any publication or use shall be notified to the author.

## Contributions

You may contribute to the development of Shadows by sending translations of the user interface, the documentation or the web site pages. In this case, your name will be associated to the contributor list. You may also suggest new features, report bugs or any problem you may encounter. These contributions though do not allow you to claim any copyright or intellectual property on any part of Shadows.

## Product integrity

You may not modify, alter, decompile or reverse-engineer Shadows files or any part of the documentation. Components and files accompanying Shadows cannot be used separately. In particular, it is strictly forbidden to alter the program to display another name than the author's name; it is forbidden to use a resource modification tool to modify menus, texts, dialogs or any texts of the application.

## Limitation of warranty

Shadows and its components are tested to the best ability of the author, on his development platform. Nevertheless, the author cannot offer any guaranty of good function on any platform or any context. You have the responsibility to ensure the correctness of the results before use. You shall verify that Shadows is working correctly on your platform (hardware and software) prior to ordering a Shadows Expert or Shadows Pro license. No refund will be possible for any reason. All sales are definitive. Shadows is designed for Windows 10, Windows 8.x, Windows 7 and Windows Vista on PC compatible computers. It is not compatible anymore with Windows XP or older versions. Shadows is now a 64-bit application and requires a 64-bit version of Windows. It should be possible to use Shadows with a Windows emulator on another platform (Mac OS, Linux, etc.), but no technical support nor guarantee will be offered in this case. The program has been tested using a recent anti-virus program before its release on [www.shadowspro.com](http://www.shadowspro.com) web site. The author is not liable even if, despite his

best efforts, a virus damages the PC or if any problem occurs. No control nor guarantee is provided for downloads done from a third-party web site. No compensation or refund is possible, whatever the damage or problem.

## Termination

Should you cease to use the program, you shall uninstall it from your computer. If you were using a Shadows Expert or Shadows Pro license, you must also remove the license association and delete your personal license file.

Thank you for reading this document through to the end!

If you are satisfied by this software, promote it around you and be an ambassador of Shadows.

Thanks.

*This page is left intentionally blank*

# Table of contents

<b>PART 1 – INTRODUCTION TO SHADOWS SOFTWARE .....</b>	<b>5</b>
<b>Introduction .....</b>	<b>5</b>
<b>Installing Shadows on a PC.....</b>	<b>5</b>
Instructions to install Shadows.....	5
Installation of the Shadows license file.....	6
Associate the license with the PC.....	6
Manually associate the license.....	6
<b>Credits.....</b>	<b>7</b>
<b>Features of the three license levels .....</b>	<b>8</b>
Shadows (freeware) .....	8
Shadows Expert .....	8
Shadows Pro .....	8
<b>Order a Shadows Expert or Shadows Pro license .....</b>	<b>9</b>
<b>PART 2 – SUNDIALS.....</b>	<b>11</b>
<b>Introduction to sundials.....</b>	<b>11</b>
<b>Designing a sundial with Shadows .....</b>	<b>11</b>
Preliminary information to collect .....	11
Quick creation of a sundial from the home screen .....	13
Create a new sundial from the File menu.....	13
<b>Choose a place for your sundial .....</b>	<b>15</b>
In the garden .....	15
On the front of a house.....	15
Inside the house!.....	15
On the roof of the house!.....	16
Elsewhere.....	16
<b>Determine the longitude and latitude of a place.....</b>	<b>16</b>
Find the longitude .....	16
Find the latitude .....	17
Enter the location in the database.....	17
<b>Find the direction of the local meridian .....</b>	<b>18</b>
Using a compass.....	18
Using the Sun's passage to the meridian .....	19
Using bisectors .....	19
<b>Find the declination of a wall.....</b>	<b>20</b>
Method using a protractor and a plumb line.....	20
Method of the chord.....	21
Method of the oblique shadow .....	21
Method of the network of tangents .....	21
Method of circle bisectors .....	22
Calculation tool for the determination of the wall declination .....	22
<b>Adjust the size of the sundial .....</b>	<b>23</b>
Size of the sundial plate .....	23
Adjust the scale of the drawing.....	23
Adjust the anchor of the style .....	23
Change the shape of the plate .....	23

<b>Visualizing and animating the style's shadow.....</b>	<b>25</b>
<b>Visualizing the shadow of a roof .....</b>	<b>26</b>
<b>Indications given by the sundial .....</b>	<b>28</b>
Choose indications .....	28
Local solar time .....	28
Solar time of the time zone .....	28
Mean time (clock time) .....	28
Italic hours .....	29
Babylonian hours.....	29
Unequal hours .....	30
Sidereal hours.....	30
Azimuth and altitude of the Sun.....	30
Analemma curve .....	30
Specific hour lines .....	31
Declination lines .....	32
Change the style and color of drawings .....	34
Changing other attributes on the sundial .....	34
<b>Decorate the sundial .....</b>	<b>36</b>
Add some text .....	36
Add a motto.....	37
Import an image .....	37
<b>Export drawings.....</b>	<b>37</b>
Copy-paste the view into another software .....	37
Export a vector drawing .....	38
Tables of coordinates .....	38
<b>Constructing the sundial.....</b>	<b>41</b>
Choose a material.....	41
Transfer the drawing on the material .....	41
Use the equinoctial ruler .....	41
Create a large sundial.....	44
Draw the construction layout.....	44
Draw the sundial lines directly from the Sun?.....	45
<b>Build the style.....</b>	<b>46</b>
Schematics of the style .....	46
The triangular style .....	46
The polar style .....	47
The perpendicular style .....	47
The polar eyepiece (pierced disk).....	47
Truncated style.....	48
<b>How to read time on a sundial? .....</b>	<b>48</b>
Longitude correction.....	49
<b>The horizontal sundial .....</b>	<b>51</b>
Geometry of the sundial .....	51
Limits of illumination.....	51
Construction .....	51
Installation .....	51
<b>The vertical direct south sundial .....</b>	<b>53</b>
Geometry of the sundial .....	53
Limits of illumination.....	53
Construction .....	53
Installation .....	53
<b>The vertical declining sundial.....</b>	<b>54</b>
Geometry of the sundial .....	54

Limits of illumination .....	54
Construction .....	55
<b>The vertical direct west sundial .....</b>	<b>56</b>
Geometry of the sundial .....	56
Limits of illumination .....	56
Construction .....	56
Installation .....	56
<b>The vertical direct east sundial .....</b>	<b>57</b>
Geometry of the sundial .....	57
Limits of illumination .....	57
Construction .....	57
Installation .....	57
<b>The meridian dial .....</b>	<b>58</b>
Graph of visibility hours of the meridian sundial .....	58
<b>The equatorial sundial .....</b>	<b>60</b>
<b>The polar sundial .....</b>	<b>61</b>
Geometry of the sundial .....	61
Limits of illumination .....	61
Construction .....	61
The declining polar sundial .....	61
<b>The declining and inclining sundial .....</b>	<b>63</b>
Changing the declination and the inclination .....	63
<b>The spider sundial .....</b>	<b>64</b>
<b>Analemmatic sundials .....</b>	<b>65</b>
History .....	65
Position of the style .....	65
Reading time .....	65
The ellipse .....	65
The horizontal analemmatic sundial .....	66
The vertical analemmatic sundial .....	67
Options for the date line .....	67
<b>The armillary ring .....</b>	<b>68</b>
<b>The cylindrical polar sundial without style .....</b>	<b>69</b>
<b>The shepherd's dial .....</b>	<b>70</b>
<b>The vertical cylindrical sundial .....</b>	<b>71</b>
<b>Bifilar sundials .....</b>	<b>72</b>
The horizontal bifilar sundial .....	72
The vertical declining bifilar sundial .....	72
<b>PART 3 – ASTROLABES .....</b>	<b>75</b>
<b>Introduction to astrolabes .....</b>	<b>75</b>
The front of the astrolabe .....	76
The back of the astrolabe .....	76
Different types of astrolabes .....	77
The stereographic projection .....	78
<b>The Planispheric astrolabe .....</b>	<b>79</b>
Rete of the astrolabe .....	79
Configuring the drawing of the astrolabe .....	81
Astrolabe for the southern hemisphere .....	83
How to build an astrolabe .....	83
<b>The universal astrolabe .....</b>	<b>93</b>
List of problems solved with a universal astrolabe .....	94

The mariners' astrolabe.....	95
<b>PART 4 – OTHER GNOMONIC AND ASTRONOMICAL FEATURES .....</b>	<b>97</b>
<b>The equation of time .....</b>	<b>97</b>
Origin of the equation of time.....	97
Convention used for the equation of time .....	98
Using the equation of time.....	98
Graph of the equation of time.....	98
Graph by months.....	100
Vertical graph of the equation of time.....	100
<b>Solar ephemeris.....</b>	<b>101</b>
General ephemeris.....	101
Daily ephemeris.....	101
Instant ephemeris .....	102
Ephemeris generator .....	102
Lunar ephemeris.....	102
<b>The solar graph.....</b>	<b>103</b>
The polar solar graph .....	103
The horizontal solar graph.....	103
The horizon mask .....	103
<b>Other graphs and tools .....</b>	<b>104</b>
Time of sunrise and sunset.....	104
Graph of efficiency of a solar panel.....	105
The mobile sky map .....	105
The protractor .....	106
The azimuth circle .....	106
The tangent network.....	106
The compass rose.....	107
Determination of sundial parameters from a photo.....	108
<b>PART 5 – EXPLORING FURTHER .....</b>	<b>109</b>
<b>Become a member of a sundial society.....</b>	<b>109</b>
<b>Bibliography .....</b>	<b>110</b>
Books on sundials.....	110
Books about time .....	112
Books about astronomical calculations.....	112
Books on astrolabes .....	112
<b>Glossary of technical terms.....</b>	<b>113</b>
<b>Frequently Asked Questions .....</b>	<b>117</b>
<b>Annexes.....</b>	<b>120</b>
How to translate the program?.....	120
Add your own mottoes .....	120
Add new locations in the database .....	121
Troubleshooting the program .....	122
Shadows End User License Agreement.....	123
<b>TABLE OF CONTENTS.....</b>	<b>127</b>

*This page is left intentionally blank*



This manual unveils the secrets of two of the most ancient astronomical instruments, the sundial and the astrolabe, by explaining how they work, how to understand their layout, and by describing how to realize them by yourself.

It is also and mainly the reference manual of the Shadows Pro<sup>®</sup> software, which makes it possible to simulate and draw these instruments on screen, with many drawing options and a great accuracy.

Become an expert of Shadows Pro<sup>®</sup> and in the understanding of sundials and astrolabes.

